

Tokoroa High School



1990
CASH

STAFF

PRINCIPAL

Mr D.S. Hill, MA (Hons) DipTchg

DEPUTY PRINCIPAL

Mr R.E. Sommerville, MA (Hons) DipTchg

ASSISTANT PRINCIPAL

Mrs B.R. Graham, LRSM LTCL DipTchg

GUIDANCE COUNSELLOR

Mr D. Hollingsworth, BEd MPhil (Hons) DipTchg

HEADS OF DEPARTMENTS

COMMERCE:

Mrs B. Pudsey, TDipT TTC ACTD

COMPUTER STUDIES:

Mr D.E. Rothwell, BSc DipTchg

CONSUMER STUDIES:

Mrs J. Mitchell, DipTchg

ENGLISH:

Mr O.R.M. Robyns, LL B (Hons) JP

HISTORY AND GEOGRAPHY:

Mr N.M. McKenzie, MA (Hons) DipTchg

LANGUAGES:

Mr D.W. Austin, DipTchg

MATHEMATICS:

Mr M. Christophersen, MSc BEd DipTchg

PHYSICAL EDUCATION:

Mr J. Griffiths, BEd (Hons)

POLYNESIAN STUDIES:

Mr R. Ngarimu, ATTC

SCIENCE:

Mr U. Drake, BSc DipTchg

SOCIAL STUDIES:

Mr T. Bentley, MA (Hons) DipTchg

TECHNICAL:

Mr D.W. Olding, AdvTradeCert TTC

TRANSITION EDUCATION:

Mrs M.M. Lennon, DipTchg

WORK EXPERIENCE UNIT:

Mr N.G. Morgan, DipTESL DipTchg

TEACHER LIBRARIAN:

Mrs M. Trebilcock, BA DipTchg Dip. Tch. Lib.

POSITIONS OF RESPONSIBILITY

BIOLOGY:

Mrs L.A. Kerbers, BSc DipTchg

COMMERCE:

Mr Te W. Paki, DipAcc BA MEd MA5c

ENGLISH:

Mrs S. Yardley, BADipTchg

MATHEMATICS:

Mrs S. Christophersen, TTC

ESL/COOK ISLAND STUDIES:

Mr T. Tangaroa, BEd DipTESL DipTchg

DIRECTOR - SOUTH WAIKATO FOREST

SKILLS COURSE

Mr J.G. Leckie, TTC

MUSIC AND CULTURAL STUDIES

Mr G. Burns

Mrs E. Kane

Mrs F. Natua

Mrs U. Faumui

Mr P. Merz

Mr P. Monga

Mr D.W.N. Saunders QSM

Mr A. Letoa

STAFF LIST

Mrs A. Atkins BEd (Hons) DipTchg

Mr Francis Beban, BComm

Mrs M. Brunton, DipHomeEc DipTchg

Mr F. Coulter, BSc DipForest Tech Mr J. Depree,

Mrs J. Flavall, MA BSc DipTchg Mrs J. Gee, BA

Mr W.J. Hutchins, BA BSc DipTchg Mr H.

Mrs K. Law, BA DipTchg Mrs M. Maa, TTC

Mr J. McHugh, BSc MI(Bio) Mrs S. McKernan,

Mrs H. Mische, DipSLT TTS

Mr I. Mutch, DipTchg Mr G. Nicol,

Mr M.B. Olsen, BA DipTchg Mr E. Rippey,

Mrs G.V. Robyns, LCST Mrs R. Schwed, ATD

Mrs A. Thompson, TTC DipTchg

Mrs J. Whale, TTC

Mrs R. Wolfe, TTC

Mrs K. Woodley, BSc DipTchg

ADMINISTRATIVE AND ANCILLARY

SCHOOL OFFICE: Mrs B.L. Gooding

PRINCIPAL'S SECRETARY: K. Germann-Scott

FREE TEXTBOOK ASST: Mrs E.A. Harpur

EXECUTIVE OFFICER: Mrs K. Kendall

PRINT ROOM SUPERVISOR: Mrs Y. Miles

LAB TECHNICIAN: Mrs S. Bluett

LIBRARY ASSISTANT: Mrs L. Brighting

CARETAKING AND GROUNDS

CARETAKER: Mr J. Jansen

CARETAKER/5-ROOM: Mrs G. Jansen

STAFFROOM: Mrs M. Fauchelle

CARETAKING: Mrs D. Vonk

GRANDSMAN: Mr B. Williamson

GRANDSMAN: Mr T. Adams

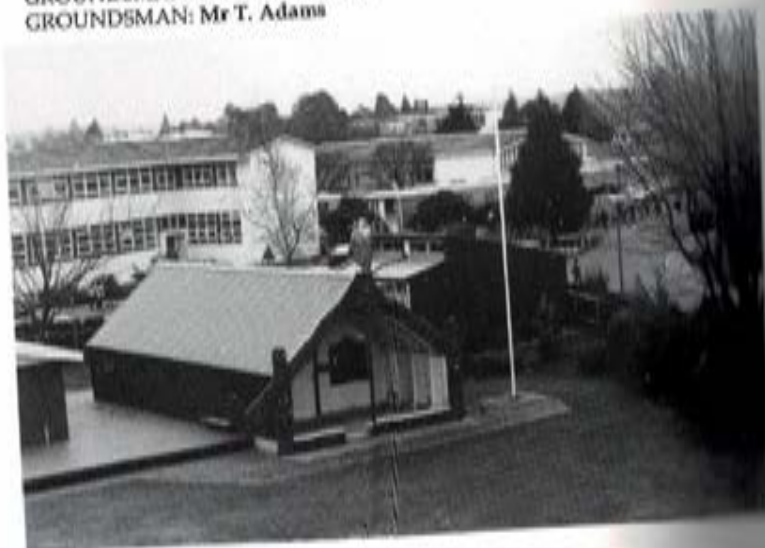

"The" Staff



TOKOROA HIGH SCHOOL STAFF

Back Row: W Hutchins, U Drake, M Olsen, I Mutch, J Flavall, G Nicol, D Woodley, C Wilson, J Depree, W Prosser.

Next Row: J Gee, R Wolfe, M Lennon, Y Miles, B Gooding, F Coulter, A Swanson, H Mische, F Beban, J McHugh.

Next Row: A Thompson, S Bluett, I Kerbers, R Schwed, T Tangaroa, M Maera, K Germann-Scott, M Brunton, S Yardley, J Whale, W Paki, P Taufalele, J Murray, V Tearetoa, G Robyns.

Front Row: S Christophersen, J Griffiths, K Law, D Rothwell, D Olding, T Bentley, T Tolovae, R Sommerville (Deputy Principal), D Hill (Principal), B Graham (Assistant Principal), M Christophersen, D Austin, B Pudsey, N McKenzie, M Robyns, H Johns.

COMMITTED



Staff Notes

Jenny Gray 1930-1990

I watched as the efficient
Secretarial machine wound down
The woman remained throughout
Unbending
Demanding more than time could give.
Tiredness etched lines on her face
With care I advised rest
With straightened back and no-nonsense look
She gave the expected retort
That there was yet more to be done.
Sensing the futility of reasoned argument
I walked away in angry admiration.
Time did catch up that day.
The empty space began to tumble with
Well remembered moments-
A shared early morning joke,
Sweeties hidden in a desk drawer,
A Can-Can after prizegiving,
Little mementos of a trip,
Confidences shared.
That once tireless energy,
Loyalty
Dedication
Efficiency
Friendship
Chased each other in eulogy.
The tears are spent
The memories remain
of Jenny Gray - Friend

Kathy Law

Hi, my name is Kaye Germann-Scott and I joined the staff at Tokoroa High School as Principal's Secretary at the beginning of Term 3. The last 15 years (since leaving High School) I have worked mainly for Finance Companies (including one year in London on a "Working Holiday"). I moved to Tokoroa 18 months ago from Hamilton when I married Peter.

I am really enjoying being back in a school environment and am finding this School a very interesting and friendly place in which to work.



MRS FLAVALL'S TRAVELS

Some experiences are unusual, exciting and happen only once in your lifetime. That is true of the experience my family and I had when we travelled together to the United States to visit my father and my nine brothers and sisters and their families and to see something of the Wild West and the California Coast — all in five weeks. We spent the first three weeks in Wisconsin and Minnesota where my family lives. It is a beautiful area, dotted with lakes, dairy farms and pine forests. Sound familiar? My children got on famously with their wonderfully enlarged family of cousins and uncles and aunts. They also experienced for the first time something I experience often in New Zealand — being told that they talk "funny". I don't think they minded. They were proud of their New Zealand accent and heritage.

We travelled by train from Chicago to all those places I have read about or seen on TV but never expected to see first hand - the Rocky Mountains, the Arizona Desert, the Grand Canyon, San Diego and Sea World, Los Angeles, Disneyland, the San Fernando Valley, San Francisco and Yosemite National Park. We have albums of photos and hundreds of memories. There are surprisingly large numbers of Kiwis on the west coast of North America sightseeing and working there. Maybe some day you'll be among them. I know you would enjoy it.

Jenny Flavall



Francis Beban

Coming onto the staff of Tokoroa High School in the third term, after arriving up from the South Island, has been a challenging and worthwhile experience. Since the first day, when my wife myself and another new staff member were welcomed onto the school marae, I have been struck by the rich cultural diversity, the talents and the warmth of everyone here at Tokoroa High School.

I can certainly see how Tokoroa has a lot to offer. I am looking forward to tramping, sight seeing and generally getting well acquainted with the region with the year's end rapidly approaching. I look forward to an ongoing association with the school in 1991.

FB.

GUIDANCE 1990

Working with young men and women at such an important time in their lives is a privilege - sharing their joys, sorrows, pain and confusion is also a privilege. I was reminded of this recently when a number of former students called in to say hello to me. At the time they were students here they were wrestling with serious problems - their lives were in crisis. They weathered the storm and now their lives have an order and a direction, and they wanted to show me that.

They talked of their successes and disappointments as well as future plans. They looked back on their time of crisis with a perspective that only comes with maturity. No hint of embarrassment, rather of a sense of achievement. They wanted me to see the new them, and in their own way say thanks for helping - thanks for caring. That thanks has to be shared with you.

At any one time in this school a number of students are in crisis, whose world is falling apart and unsafe. Many of the students we find out about because a close friend expressed a concern. This is a feature of our school community - it is a caring place and long may that be so. When someone is in crisis that someone needs the support of others. Being supported sometimes means the difference between wanting to live or not wanting to. I want to say thank you to the many friends who sought help for their mates, and I want to thank the many teachers who have noticed when things started to go wrong. It is this caring that shows that Te Whanau A Noa is something real and not simply an expression.

D.Hollingsworth



CHAOS has come again!

Talo Tolovae

1991 will be a challenging year. I will be studying towards a Master's degree in Education at the University of Waikato. This is a two or three year full-time study and I will take full advantage of it. I intend to complete four of the papers next year and the rest in 1992. As it is an education degree, the majority of the papers will be in Education and one or two in English. It will be difficult but exciting.

'Whakamarotia atu ano, kia whakahokia mai ki te Kapua Whakapipi'.

'Go forth in life as the shag stretches out its neck in full flight, only to return home.'

Kia ora
Kia orana
Talofa lava
Malo lelei
Greetings,

I have been a member of this family - Te Whanau a Noa for the past five years. I consider myself very fortunate to have spent this time in the company of people such as you. Living and working in this environment has helped me to develop more as a person and learn more about being a teacher.

Upon my acceptance of a position at Tokoroa High School I met for the first time the precious principal - Mr Geoffrey Burrige. I was only to know him for two short weeks till his death, however in that time I came to admire his honesty, forthright manner, and his willingness and ability to move mountains to get a job done.

Kei te mihi ano ra ki a koe e te Rangatira
Kua puta mai etahi ou whakaaro e pa ana ki te Whakapapari i o tatou tamariki i roto i o ratou ake reo, tikanga hoki

No reira, moe mai e koro i te ringa matau o te Ariki
I have found it very difficult to separate the feeling of family that is Te Whanau-a-Noa and the school of Tokoroa High School. To me they must be the same thing. In my opinion the future of this country in regards to developing sensitivity and understanding of others and their different cultural values and beliefs must surely rest in a school based marae like Te Whanau-a-Noa and the dedication and open mindedness of the individual members of the Whanau-family to making it work.

No reira - Kei te mihi ki te koroua a Noa
Tu mai ra e koro i runga i te reo aroha,
i runga i te reo karanga o tou iwi e hui mai ana.
In conclusion Irene and I would like to thank the family of Tokoroa High School for the warmth with which we were welcomed into this place and the many warm expressions of Aroha, Manakitanga and Whanaungatanga.

no reira - E hoa ma
Kia piki te ora, Kia piki te kaha, Kia piki te maramatanga.

Na Henare and Irene



PRINCIPAL

The school magazine provides us with a kaleidoscopic picture of what has been happening at Tokoroa High School this year. In particular it highlights student activity and achievement. 1990 has been another year where a large number of the Tokoroa High School family have had personal and group successes and like members of any family we are proud of these successes in the academic, sporting, cultural, musical and dramatic fields, and they are all reflected in the magazine.

The magazine is the result of a high degree of student effort and involvement. It was such effort and organisation that made the Senior Ball such a success, and has seen the School Council making grants to a significant number of students so they could take part in a variety of challenging activities. This same willingness to get involved was behind the successes of our sports teams, our musical production, school newspaper, mime group, Te Puna Wai Ora and the Talent Quest. So here it is, 1990 in summary. It's been a good year but 1991 will be even better!

David Hill
Principal



STAFF TRAMPING GROUP

Over the last year several tramps were undertaken by members of staff, their children and friends. The photograph shows a typical mix - a Scot, two English, a Swede and even a Kiwi.

The volcanic crater is of Tarawera and although cloud was down to mountain level, Mr McHugh was introduced to the life scenic beauty of central North Island.

If the New Zealand Immigration Service had been less thorough/touchy I would have spent five years on leaving this summer.

An interesting time with many new experiences for me and I hope of benefit to the pupils I have taught. The very friendly atmosphere generated by the pupils and staff has been appreciated.

To someone from overseas a source of great pleasure has been the activities on the Marae where pupils have carried out their activities with pride and confidence. Equally, to go to the school hall and YMCA and observe Cook Island and Samoan pupils performing and dancing with such obvious enjoyment.

Or to take part in so many tramps where pupils have coped with arduous and exhausting situations but have returned home with increased confidence and self respect. These are the memories I will take with me.

W.E. PROSSER



COMMUNITY EDUCATION

1990 has been another growth year in Community Education with a selection of 12 new courses being added to the programme. Some 720 adults enrolled in day and evening classes, a slight increase over 1989 enrolments.

Popular additions to the evening programme have been Indian cooking, Photography, Patchwork quilting and preparation for Driving licence. The day class programme also included courses in Interior decorating and design, Video film-making, Reflexology/Floral art. In total 42 short courses and 17 year long courses were held this year.

1990 has also been notable for the increased liaison between the school and community organisations with courses run in conjunction with Tokoroa Art Society, Tokoroa Tough Love Group and the Women's Health and Resource Centre. In 1991 we will be running courses in conjunction with Plunket society, St Johns Ambulance and East Waikato Playcentre Association.

New courses planned for 1991 include Indonesian Cooking, Positive Parenting, Jazzergetics, Introduction to Fashion Modelling and a range of courses in advanced computing with eight new tutors offering courses in Term one of next year.

With the evening programme now in its final weeks we wish to thank the many tutors for their various contributions to community education this year and we wish those adults sitting School Certificate Subjects the very best in their forthcoming exams.

Trevor Bentley and Ann Swanson



COMMUNITY EDUCATORS

Back Row: H Warburton, K Fletcher, J McHugh, U Drake, K Stuart, N Janetzki, L Murray, L Moore, G Ackerman.

Middle Row: V Crocker, J Herlihy, B Shadbolt, J Whale, J Murray, I Stewart, G Nicol, W Paki, D Rothwell, P Govender, P Taufalele, C Allen.

Front Row: M Maca, G McEwan, R Keightley, N Flint, H Mische, A Swanson, D Hill (Principal), T Bentley, E McCabe, G Janssen, L Ryan, J Belfield, T Berg.

BOARD OF TRUSTEES

1990 has been a year when "sesquicentennial" has been added to the vocabulary of New Zealanders. It is not a pretty word, but it brings with it a feeling of a time when things happen.

A lot has happened at Tokoroa High School in 1990, and the Board of Trustees has been proud to be part of the movement. None of it could have happened without the support of our principal, David Hill, a very professional and willing staff, enthusiastic students and co-operative parents and caregivers. It is very reassuring to know that we are all working in the same direction, for similar goals.

The school's mission statement says that we exist to provide each student with the opportunity to fully develop their physical, cultural, intellectual and social potential.

The Board takes every word of that mission very seriously. Our job is not to run the school - we leave that in the hands of the professionals - but rather to provide the wherewithal for the school to operate, and to check that it is functioning according to our mission and stated goals.

Whenever I visit the school I witness our policy in action. The almost eerie silence of SSR; the enthusiastic uproar of half the school skipping for health; the awesome talent at concerts; the successes in so many different sports, contests and extra-curricular projects; the innovative suggestions that are brought to us by both staff and students - this is a school on the move, taking the concept of all-round education to heart.

We all stood on our marae together, shed our tears and supported each other in our sadness with the sudden loss of Jenny Gray. Jenny had been at Tokoroa High School for almost 25 years, and she had firm ideas on what our school stood for, and much of it was demonstrated that day in her honour.

As examinations loom, the Board looks forward to seeing tangible results for all the work that has been done this year. Staff have provided many extra hours of tuition and revision for students. We wish you all your just rewards - and that little bit of luck that never goes astray.

In 1991 we leave "sesquicentennial" behind us, but I hope that we will go forward together "in spe fortitudo" - our school motto which means "in quiet confidence lies your strength."

Marg Sewell



TOKOROA HIGH SCHOOL BOARD OF TRUSTEES

Back Row: Mr Murray Trebilcock, Mrs Kay de Ruyter, Mr Don Austin (Teacher Rep).

Front Row: Mr Danny Thompson, Mrs Kaye Germann-Scott (Secretary), Mr David Hill (Principal), Mrs Marg Sewell (Chairperson), Mr Gerry Portegys.

Absent: Mrs Moerua Maen (Co-Opted member), Mrs June Ormsby (Co-Opted member), Miss Terepili Rota (Student Rep).

STUDENT REPRESENTATIVE Board of Trustees

This year, I have been privileged to act as Student Rep on the Board of Trustees, for the school. On the last Thursday of every month, I have had to attend a meeting with the other reps on the Board. These meetings usually last for 3-4 hours.

The members of the Board are all very consistent people and are all easy to get along with. All of them are not only supportive of me but are also supportive of everyone else who attends Tokoroa High School. The Board is made up of people whose best interests lie in the education of their children.

The Board has sub-committees and it was suggested that I be on the "buildings and grounds" committee. Mr Murray Trebilcock is the head of this committee. Generally, our responsibility is to make sure the school is in good condition. I think that for me, the hardest thing about being student rep is attending a meeting where you are the only teenager.

Apli Rota

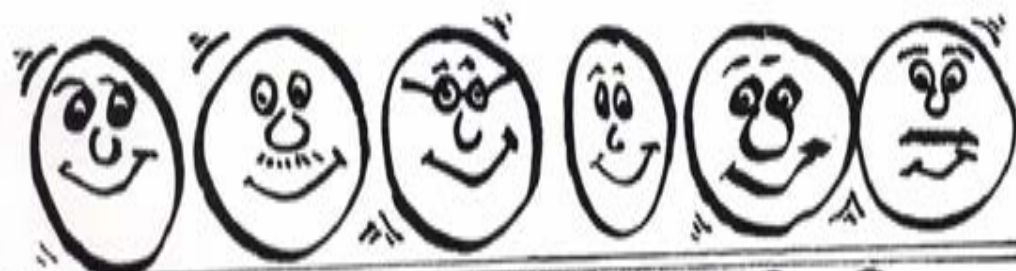

BORED OF TRUSTEES ?

School Council



COUNCIL REPORT

1990 has proved to be a very successful year for our THS Council. Throughout the year we have participated in many activities and raised money in various ways. This year's council was headed by Ella Hoeflich and Larn Wilkenson with the help of their secretary, Michaela Nill and treasurers, Ruth Newfield and Tereapii Rota.

The council's fund raising activities included three socials, four mufti days, a mufti week, a variety show and an extremely successful Senior Ball. All these were supported well by students which enabled the council to support many others in their activities. From sports representatives to academic camps to books for our visiting exchange students, our funds have been channelled throughout the school.

Not only did the council raise money for distribution within the school but we also helped Mrs Brunton with the running of "Jump Rope for Heart". Money was raised for the National Heart Foundation, and everyone had an enjoyable time doing it.

Earlier in the year we met with the Forest View High School Council for a joint meeting. This was a great experience which gave us a chance to learn more about how they run their council and at the same time meet new people and have a good feed!

1991 may see some drastic changes to the structure of Tokoroa High School if the new Whanau system is introduced. These changes will mean the council's structure would also have to change. A group of students from this year's council has been meeting with teachers during the year to discuss this new system and how it will effect the council.

In October this group printed a handout detailing its conclusions and asked for everyone's comments. Overall the response was positive and changes may be on the way soon.

Over the last 12 months, the council has contributed to many aspects of school life and has had a rewarding year. If you are thinking of running for the council next year, I suggest you do, it's well worth it.

SCHOOL COUNCIL

Back Row: Sam Pahewa, Jamie Millwood, Ollie Ryan, Adam Ellis, Reynold Ropiha, Robert Rogers, Ma Petero, Avian Curtis, Tino Tuau, William Hirinuki, Olly Webb, Rangi Davis, Desmond Hoeflich.
Middle Row: Mrs Christophersen, Matilda Ropiha, Sharie Gray, Sarah Mace, Arama Ngapo, Treena Tetava, Raewyn Bates.
Front Row: Lorraine Laird, Moe Putai, Apili Rota, Ruth Newfield, Michaela Nill, Ella Hoeflich, Larn Wilkenson (Chairperson), Lisa Pitman, Emily Trebblecock, Ngawini Poumako, Ngawai Wilkinson, Kathy Erskine-Shaw, Miranda Snell.

From being a council member last year, to the Chairperson this year sure was a big jump. Not only did I take on more responsibilities, but I also became more involved with more school activities.

This year we raised well in excess of \$6000, and it seemed that as just as we made it, we ended up giving it away.

We supported things from the Hockey team to New Zea-

land representatives, from AFS students to the Final Assembly, and many, many more. Although this year most of our money went to sporting groups and representatives, I would like to say that we are not only here to support sporting events, but also academic achievements as well. Hopefully next year support for sporting and academic achievements will balance out.

We raised money from three socials and about six mufti days and one mufti week. But our biggest achievement by far this year was the Senior Ball, where we catered for nearly two hundred people. Congratulations must go to all those who helped with the ball, as it was a huge success!

Thanks to all those on the council for all their work and effort, it was a truly bodacious experience.

See ya later dudes! And thanks!

L. Wilkinson



Moonlight Night



A MOONLIGHT NIGHT

Star light, Star bright, Shine your light on me!

The Tokoroa High School Ball 1990 discovered many new "stars" on Saturday, August the 4th under the full moon. The evening was filled with glitter, glamour and glory. It was a night never to be forgotten. A night where the girls looked chic and the guys were so suave. A night with a little bit of waltzing, a bit of talking and a lot of eating! The moon found favour in and centred its light on a delightful couple by the names of Moonlight Maddie and David alias Tanya Tetava and Arran Gray. Adorned in a romantic setting, thanks to the brilliant skills of our decoration committee and talented "backdrop" artists, not only did the stars shine in the sky but also in the eyes of our Cinderella, Michaela Webb and Prince Charming, Ken Wibunsin.

Many experienced a new taste in wining and dining under the moonlight, moving and grooving to the unique but "different" Wild boys who showed just how "wild" they were!

Amongst the glamour and glitter, romance and passion the mad rush for photos to catch that special moment was obviously a favourite pastime for many of our moon followers.

So as the moon light descended slowly upon this picturesque scene, all the lovers, friends and invited guests were found feasting, conversing and enjoying.



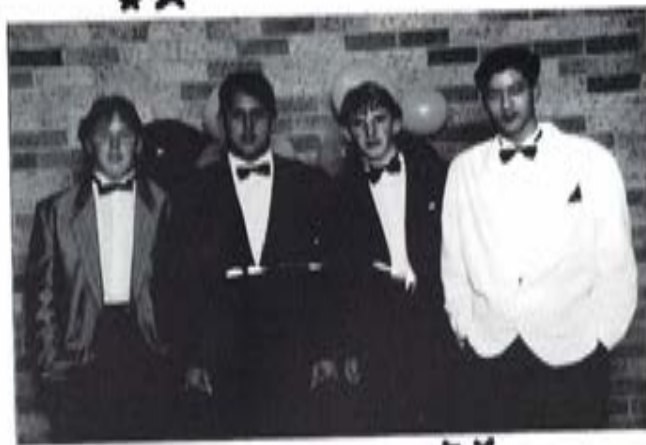

EXCHANGE STUDENTS

GAME TO T.H.S 1990

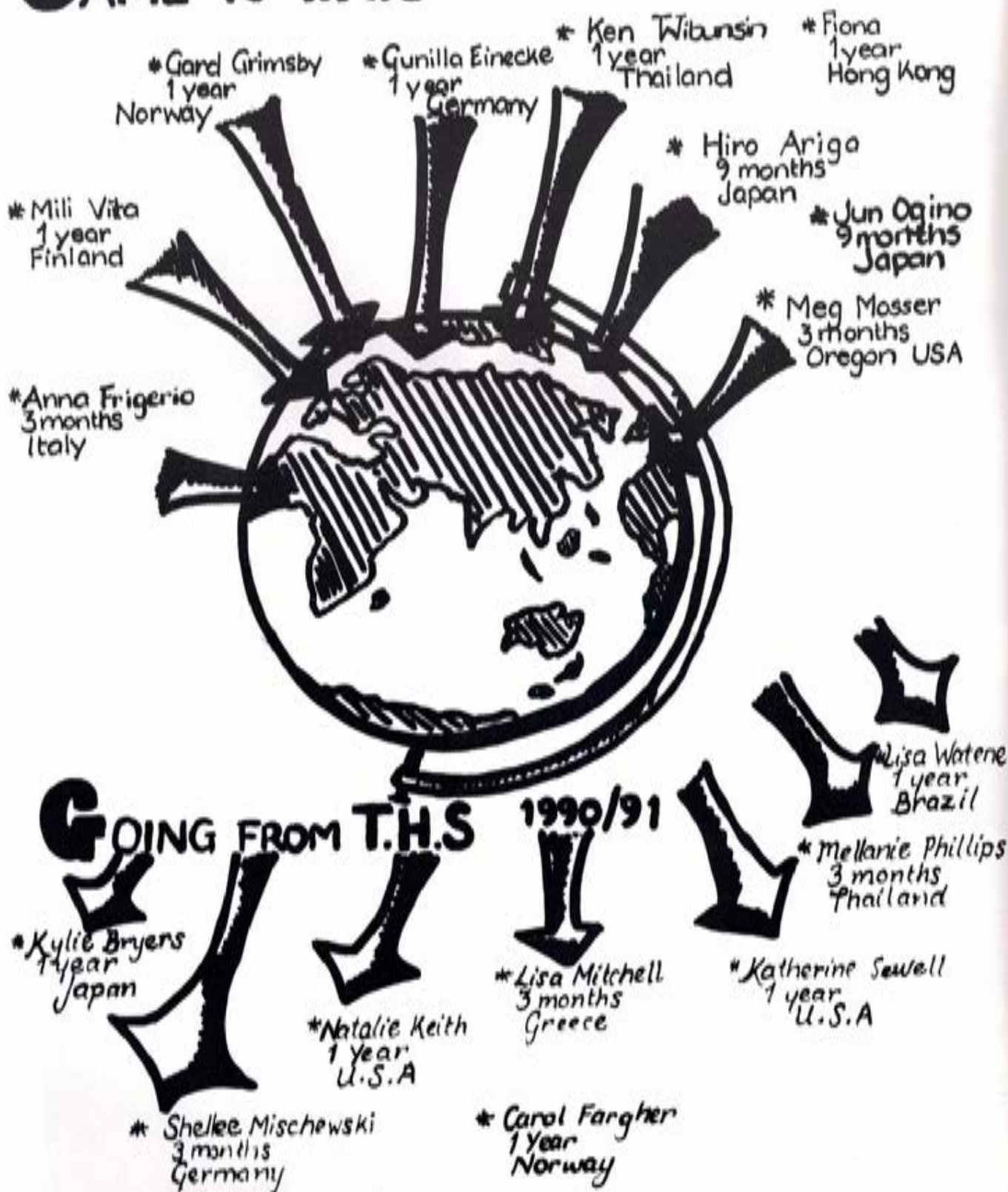

HI EVERYONE!

I guess most of you know who I am but I will introduce myself nevertheless just to make sure. I am Gunilla Einecke (most of you call me Gunni, it's easier) from Germany. I came to Tokoroa in January this year as an ASSE exchange student, and now my time is nearly over. I am going home in December. The time has gone so fast, probably because it was such a great year. I did things I had never done before - tramping, helping with the Operatic society, a helicopter ride to the glaciers and many other things. I will miss everything so much when I am back in Germany, but hopefully I will come back to New Zealand and Tokoroa one day.

I don't know what else to say apart from .. Thanks very much to everyone for making this a great year for me, especially Tokoroa High School and the Lachmans, my host family! Bye, don't forget me.



Gunni



MOI!



My name is Mili Viita (not Milli Vanilli). I am an ASSE student from Finland. I arrived here in New Zealand in January 1990 and will go back in December 1990. I come from the capital of Finland, Helsinki, and staying in a small town like Tokoroa was really different. I have enjoyed it though, but I do miss the neon lights and nightlife.

School here is so different. At home we do about 15 subjects and it is much more competitive. So this year has been a holiday for me, I don't know how I'm going to cope when I go back!

This year has been a wonderful experience I will never forget. I've seen so much different culture, a new language and a different way of life. I will go back changed (my friends will probably send me back).

Thank you to the staff and students of Tokoroa High School, hope to see you in Finland one day!

Mili



FIONA

Nearly half-year I was still like a stranger at school. I was always thinking what people thought of this "Chinese". I became shy and quiet. I was totally opposite in Hong Kong. Maybe, the difference between language and culture. I did not know.

But, after other support of New Zealand students I took part in the "Talent quest" and I was not thinking what people thought any more. I just do it and I was really enjoying it. After that, I knew more students at school. And I had joined them to play "touch rugby". (I could not believe I was brave enough to do that.)

So, before I go back I need to say "Thank You" to all of you and I hope I would have a chance to see all of you again.

Fiona Wong Chun Wah
Hong Kong Exchange Student



Kia Ora, Hello, Konechewa, my name is Hirotuna Ariga. I have been a part of New Zealand for a long time now. I arrived in New Zealand on October 6, 1989 and I am returning home on July 6, 1990. I am going home very soon.

When I arrived in this beautiful unique country I was very scared but always asking myself all kinds of questions. I was very anxious to explore. When I got to Auckland I thought that Auckland was a town, not a city. My journey to Tokoroa was very exiting. I saw many cows, forest, sheep, green fields, plenty of space, breathed clean air and the roads were empty!

When I arrived in Tokoroa I met my host family. I saw many pretty things as well, but everything was just moving too fast.

I found the language very hard to understand. English was very difficult at the beginning, everything all sounded like a tongue-twister, and sounded as if everyone was having a race to talk. When I didn't understand something I always said, 'oh yeah', or 'OK', or 'Yes', I was too scared to ask questions or say the wrong thing.

I like the town 'TOKOROA' because it is a good place with many sporting facilities. I can play rugby league, golf, rugby, swimming and volley ball. I also like the multi cultural aspect of the town and the many different kinds of people, who were always nice to everyone. It didn't matter if they were black, white, ugly or Japanese (like me!) The communication was really good and so open with everyone. Everybody is so interesting for me!

My host family Colleen, Sharie, Deidre and Arron Gray were all very, very kind to me. They slowly taught me a great many things. It was good to have a good brother - Arron, and good sisters - Sharie and Deidre, and a lovely, loving parent - Colleen, I will always have a place in my heart for them. I will miss 'clean up your room Hiro,' as mum would say. In Tokyo mum is old, doing all the work, tea, cleaning and all the chores for the children, and dad only works for the money and nothing else. But New Zealand - young mother, mum does tea, dad and children help with all the cleaning and dad still brings money home.

Kiwi wives are much stronger. I really love the New Zealand help and everything and everyone treated evenly, even boys and girls.

School is very different here than in Tokyo. Here we walk to school, in Tokyo we go to school early by train and come home late by train all the time. Studies here are very - very easy. I only have five subjects, but in Tokyo 15 subjects and we always have to study. Teachers are like good friends, always joking with teaching, and you can always ask questions and yet talk slowly and the teacher shows you with patience. But in Tokyo teacher's always lecture you and always growling when you are wrong.

I really like the way Tokoroa High School pupils are treated like part of the family, and when you're welcomed onto the Marae it makes you feel so special, you feel as though you have so much importance to everyone. That made me feel like part of the family and I felt the love of people when I lived with strangers. Even though I couldn't understand a word that was being said I still felt the Aroha.

When I go I will miss all my friends, and everyone who helped me through this strange country, I will miss mince pies, fish and chips and all my very good friends and teachers. I will always miss my family and will always love everyone all so much.

Hirotuna Ariga.

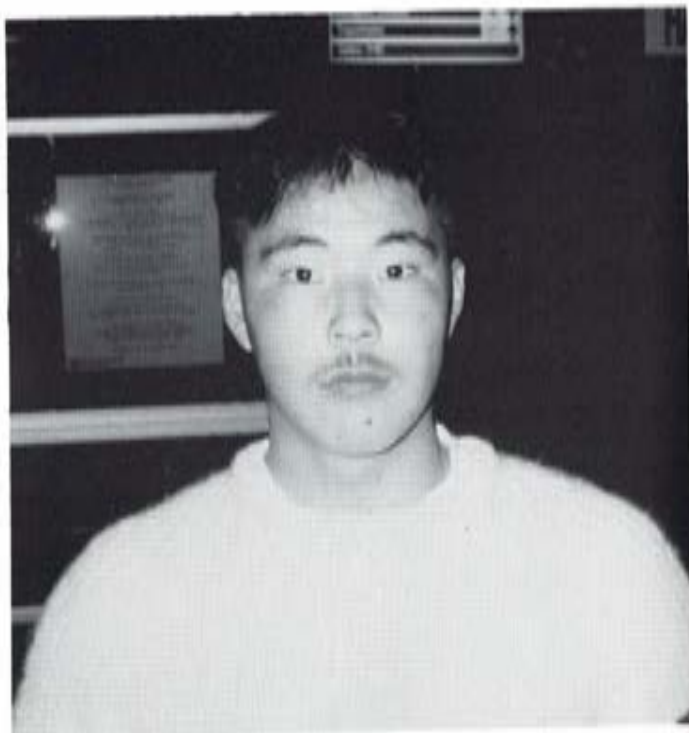

ANNA

I have spent only two months here in New Zealand, maybe not long enough to visit every place and to know everything. But, they have been the most different and interesting months I have ever spent. Everything was so exciting and new for me: the school, the food, the weather, and the language! Most of all what made this time so special were the people: so friendly and kind, so I have to say thanks to all my school friends who helped me to find the right room everytime because I got lost all the time and made me smile everyday of my stay.

Thanks to all the teachers who have given me the opportunity to learn something new and have been so helpful. And thanks to everybody for making this the most beautiful experience of my life!

Hoping to come back again ...



My address is:
Anna Frigerio
Piazza della Resistenza 43
20099 Sesto San Giovanni
Milano
ITALY

A YEAR WITH THE KIWI'S

I, Gard Grimsby have been an exchange student at Tokoroa High School for almost one year now, I have been living at John Barr Ford's place in Clyde Street together with my New Zealand brother and sisters.

Before I came here, I didn't know much about New Zealand except that it was beautiful. I soon discovered that you were driving on "the wrong side of the road" (not the right side), that the sun is in the wrong place etc. I have had a go at most of your sports like cricket, rugby, touch, netball, surfing and bungy jumping, which are all things we don't do in Norway.

In my school holidays I have been travelling around and I have seen quite a lot of the two Islands, and I like it. In the May holidays I went up to Cape Reinga, and in the August holidays I travelled around the South Island with a group of ASSE exchange students. I love Queenstown!, but Tokoroa is a nice place too, and I'm having a great time here.

I live 40 km from Oslo in Norway, so if any of you Tokoroa High School kids come to Norway one day, you are welcome to stay at my place.



Gard Grimsby

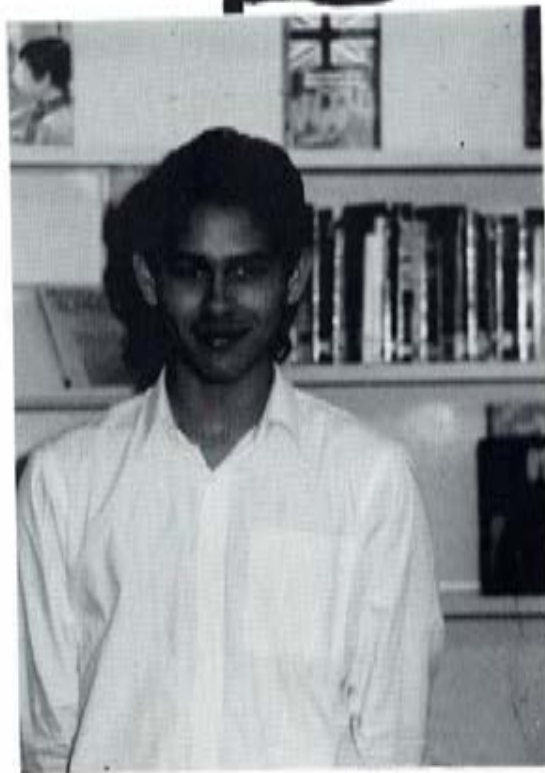

Hi, I'm Ken from Thailand. My full name is Totsapon Kenneth Wibunsin. I arrived in New Zealand on the 22nd of January 1990. I'm staying with the MacMillan family and they are always very nice to me. They certainly give me a good impression about New Zealanders.



I come from the capital of Thailand, Bangkok, a city of 7 million people. I go to a Catholic school in Bangkok. There are 4,000 students and around 100 teachers in the school. It is an average size school with 6 buildings and they range from 3 to 6 storeys high. It is called "Saint Gabriel's College". Before I left, I was in the Science-Biology program and I had to take 13 compulsory subjects. The school starts at 8.00 am and finishes at 3.20 pm. There are 7 periods in a day and each of them is 50 minutes long. We stay mainly in 1 classroom and the teachers change around every period. We only get out of class when we go to the science labs or the gymnasium.

Every day, I have to get up and get ready for school at 5.00 am. I leave the house at 6.00 am and get to school around 6.25 am. The school doesn't start until 8.00 am but the reason I have to leave the house very early is to get away from the famous Bangkok's traffic. If I leave the house at half past six, I will be late for school.

In New Zealand, I'm very spoiled because I can get up at 7.00 am and get ready. I don't have to leave the house until half past eight and it only takes 7-10 minutes to walk to school. I find New Zealand's school and education system quite relaxing. I only take 5 subjects plus LRS. The students here are friendly and very helpful. I found it was hard to make friends the first term because English was a bit of the problem. But now I've got lots of friends.

In April, I went on 7th form camp. My option was tramping in Tongariro National Park. It was a lot tougher than I expected. Anyhow, I'm glad I survived. Besides Tokoroa, I've been to many places such as Auckland, Hamilton, Taupo, Tauranga, Mt Maunganui. In the August holidays, I went to Wellington, Christchurch, Dunedin, Queenstown and Timaru. It was one of the best holidays in my life and it was a great opportunity to see New Zealand.

I am leaving New Zealand on the 4th of January 1991. The good times always go by quickly. I will miss all of the teachers, my friends and my family. I will come back when I have the opportunity. Thank you very much everybody for making this year an unforgettable year for me.

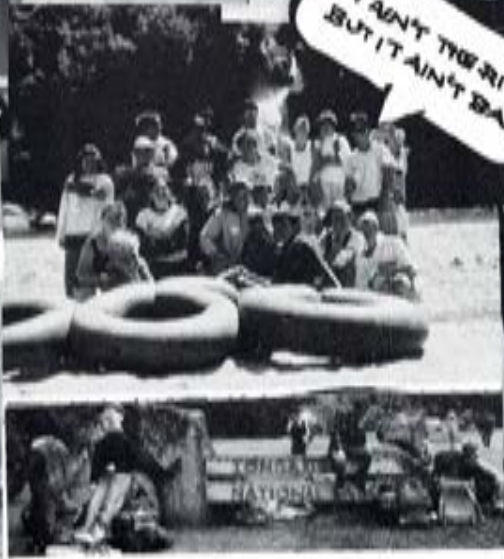



Can we do it together?
This man has seen many Pacific sunsets - his story is yet to come

Te Puna Wai Ora

"COOK ISLAND"

KIA ORA, TALOFA LAVA, KIA ORINA AND GREETINGS

Banana's is one way to describe the Cook Islanders' section of Te Puna Wai Ora or fresh from the coconut tree. The name "Banana's" has been with us for who knows how long. This year has been a boring year for us, we've not been able to show off this year to the public. But we take things as they come. We got the chance to perform at Forest View High School's concert to help raise money for their trip to Australia. Those who witnessed our performance thought we did very well, in which we did do a good job. We were so grateful to support our rival, Forest View High School.

Then along came the Tokoroa High School talent quest. Where TPWO opened the show starting with Te Au Tangata Ainoa, then followed by us, the Cook Island sector, and again given a lot of gratitude for our performance that night.

At times we were unable to have the Maori sector join us at performances, but they supported us very well and hope things work out for them next year, and to the Samoan group who also did well. A lot of thanks goes to you. To our students who participated in TPWO (Cook Island sector) Te Au Mapu Samoa, Papaa, Maori. I hope you enjoyed your year living the Cook Island culture, within the school. Many students contributed very well to keep our culture going especially to all our seniors, juniors, Chookz Myself, Little, E Te Vai Atura, thanks for helping out with our tutors.

Our tutors Pia Monga and Poko Natua thanks a lot for what you both did for us this year, through your knowledge and understanding of the culture. Although Papa Monga was sick most of the time, Poko was still there to keep things going.

Back to us and big thanks to Mama Noo Monga. Also last but not least thanks to Mama Maea and Papa Tangaroa.



COOK ISLANDS PUNA-WAI-ORA GROUP

Front Row: P Natua (Tutor), M Rikiau, N Rawiri, S Poko, L Drollet (sitting).
2nd Row: M Drollet, M Joe, T Makiakama, Mama M Maea (Teacher, kneeling).
Back Row: P Monga (Tutor), E Monga, T Simiona, T Natua, T Enoku Ben, I Vavia, W Tunkana, Daniel, R Monga (Group Leader), T Pilato, T Tangaroa (Teacher in Charge).

"MAORI"



MAORI GROUP PUNA-WAI-ORA

Front Row: Michael Little, Trevor Dean, Larn Wilkinson, Sheree Reidinger, Treasa Tetava, Ngawai Wilkinson.
2nd Row: Kara Ackerman, Kapree Kiripa, Kerry Shaller.



"SAMOAN"



SAMOAN PUNA-WAI-ORA GROUP

Most of students are not present.

Front Row: P Natua, U Faumul (Tutor), M Maes (Teacher).

Back Row: T Tangarua (Teacher), C Stowers (Assistant Tutor), E Monga, W Tuakana, Ben Tolofua (only student present), T Natua, Papa-A Letoa (Tutor-in-charge).

A. LETOA

Samoan Puna Wai Ora 1990
Talofa Lava, Greetings to you all.
Tutors 3
Roll 20 students

Letoa and I are so thankful for the attendance of our Samoan students in the class, to carry on the culture, with songs and dances. Not only that, we encourage them to behave and respect the others, especially the teachers etc. We also teach them the twenty third Psalm, the Lord's Prayer and the Ten Commandments. Also our happy feelings about the few Pakehas and three Maori girls joining in. But we are very sad so few of our best students in the class are left. Like Ricky Gaugatoa, who left for Australia, good luck for his study, and also Emma Seau she's taking a course at the PIPC Trust. Good luck to her. Anyway our old student who willingly comes in to give us a helping hand, thanks to him. Charlie Stowers. May we say, be brave and work hard for your study girls and boys, God be with you all the way. We love you all. Manuia lava le kirisimasi maua fo'i se tausaga fou fiafia. Merry Xmas and a Happy New Year.
Soifua,

A. Letoa and U. Faumul

Talofa lava tama Samoa,
Malo lelei mai Tonga,
Kia ora mai Niu Sila,
Aere mai Rarotonga.

Being a member of the TE PUNA WAI ORA, is a great opportunity that has been given to all the polynesian students to learn more about their own culture. We Samoans love to learn our own fa'a - Samoa which means a great deal to us. Most of us in our Samoan group can speak the language properly, that's including some of the New Zealand born. I am so proud of our group throughout this year, because they put in a great effort like playing guitars, performing dances and singing songs and hymns. We'd love to do anything to represent our Kulupu Samoa in school competitions, because we've got the Samoan power with a pakeha brain hil hal, joke man!

La manuia lava le alo atu mo le kirisimasi ma le Tausaga Fou.

**Love from
Tali, Louisa, Taula**





PEI TE HURINUI SPEECH CONTEST

A speech in Maori is vastly different from a speech in English. With a Maori speech you don't use cue cards, and rather than speak for a maximum of four minutes, you speak for twelve minutes.

So if you can imagine speaking in front of a thousand spectators with about twelve or thirteen video cameras on you then you can probably imagine just how nervous I was.

We left on the Wednesday morning at "2.30am" and finally arrived in Blenheim at about half past two in the afternoon. After the powhiri we all went off our separate ways to our own accommodation.

The following day was mainly a day of observation and rest as I didn't have to speak until Friday.

On the Friday we found out that I had been changed from eighth speaker to "first" so this added to the nervousness.

Although I didn't gain a placing I thoroughly enjoyed it. But I could never have gotten that far without the help of Mr Ngarimu, Mrs Barrett, Mr and Mrs Ormsby and all of my supporters who came with me. I have never had such an enjoyable trip and it's an experience I will never forget.

Nga mihi atu ki aku mahita, me aku Koro raua Ko aku Kui, me aku hoa ano i tautoko ahau. No reira, Nga mihi atu ki a Koutou Katoa, A Tena Koutou, Tena Koutou, Kia Ora Tatou Katoa.

PEI TE HURINUI GROUP



Speech Contests 1990

The ability to articulate our thoughts in both conversation and at public forums requires a complex set of skills which schools are increasingly recognising in subject prescriptions at all levels. The speech contests available to each year level provide the public forum for our students to develop oracy and enhance their confidence and self-esteem.

The 1990 junior speech contests attracted a record number of entrants; with 14 competing at each year level. The attentive audiences crammed into the library to listen to high quality speeches on a wide variety of informative and entertaining topics. So enthralled were our fourth formers that not a murmur of protest was heard when their contest continued through most of interval.

Judges, Cath Hardie and Noeleen Thode from Tokoroa Intermediate, commented favourably on both the speeches and the audience response.

The winners were Tau Gaugatao who won the third form with a speech entitled "My Sister" and fourth form winner James Swanson who spoke on "Fogey Fashions". To give some impact to his message, James dressed as a dapper young man of the 1960's.

English staff are to be commended for teaching the skills and generating the enthusiasm which was evident.

In contrast with the juniors, the number of senior contestants was disappointing. Thirteen students initially entered the Form Five contest but by "D Day" this had shrunk to seven!

However, a high standard was evident on subjects as diverse as Pig Hunting and Rape made this contest an interesting one.

Davina Edwards, a poised speaker with a strong sense of commitment to her subject, was a clear winner with a speech entitled "Helping Maori Students to Succeed". Place getters were Felicity Misiluti (2nd) and Teokotal Tarai and Natalie Kalo (3rd equal).

Seventh formers took no part in the contest again this year; a disappointment. The nine sixth formers who completed showed a sound knowledge of their subjects and developed a warm rapport with their audience.

Joseph Vavia won with a persuasive speech on "Unemployment and Education" with Arama Ngapo (2nd) and Lisa Mitchell (3rd). Judges were Karen Iverson and Alan Gleason.

I would like to thank our judges for their willingness to take time off work to assist our school and their encouraging comments.



JUMP ROPE FOR HEART 1990

Tuesday 9 October 1990, 12.15pm and four hundred students swarmed onto the tennis courts full of enthusiasm, fifty-four teams with names like "Bentley Beasts", "Girls for Green Peace", "Ninja turtles" and "Superskip-pers" all started to bounce to the beat of Tyson and Reynolds magnificent music machine.

The tennis courts were transformed into a carnival arena where teams of six bounded and rebounded over skipping ropes for 3 continuous hours ... and all for a very worthwhile cause. Money raised through sponsorship would go to the Heart Foundation with 20% of funds being returned to the school.

This is the first year such an event has been held at Tokoroa High School, but such was the success of the day that organisers hope to make it an annual event.

Thanks must go to the sponsors who made the day more interesting and challenging for the participants.

We'd like to thank: Action Connection, Tandy's, Graham's Paper Plus, Elders Sports, Willowlea Orchards and Country Foods.



Competitions were won and records set by the following people:

Marathon skipping: Nerida Rawiri, 12 minutes.

Press-ups while skipping: Sonny Tanuvasa 42 pressups.

Other prize-winners were:

BEST DRESSED TEAM: Girls Soccer XI; **RUNNERS-**

UP: "Da Girls" and "Nees Comme Originale"; **BEST**

GROUP ROUTINE: Girls Soccer XI; **SPOT PRIZE:** Cory

Thompson.

Many people worked hard to organise the Jump Rope Day.

Thanks to Mrs Mitchell and her team who made available a scrumptuous selection of food, Tyson and Reynolds who organised the sound system and the school council who set up the courts.

Most of all, thanks to all the skippers who kept going for 3 hours!

See You Next Year!

Margaret Brunton

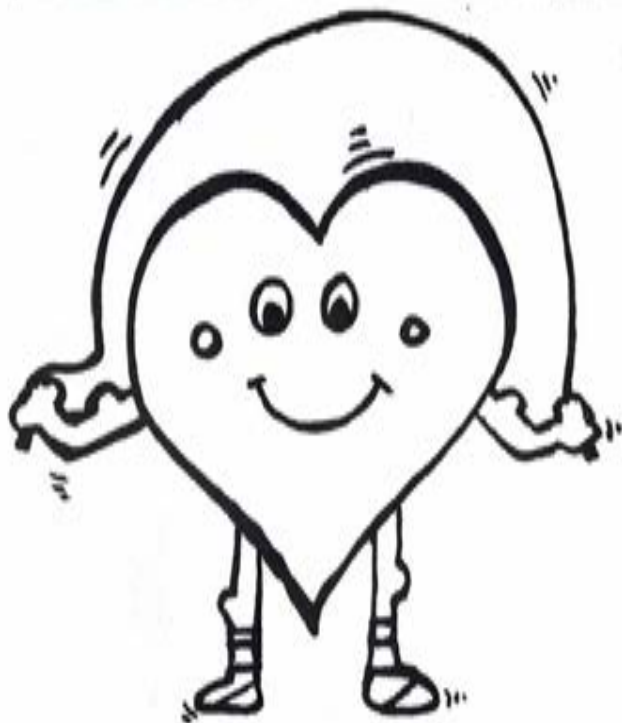

INSTRUMENTAL GROUP

The small numbers in the Group this year is well compensated by the quality of the performers. Three of our members have earned a place in the Waikato District Youth Orchestra. They are Brad Flavell on saxophone (FIII) Mark Steadman on Eb Bass (FIII) and Monique Flavell on clarinet (Tainui Int). Other players are Tyeson Wicks, guitar (Fvi) Derek Steadman, tenor horn (Tainui Int), Emily Trebilcock, flute (Fvi) and Mili Viita (Fvi) or flute.

Mrs Kath Woodley (staff) joined us on cello. The continued support of Mr and Mrs Alan and Penny Steadman on clarinets or saxophone is always appreciated.

In the first term two violinists joined with us, Mr Steve Lachman and Gunilla Einecke, and Mr John Depree on saxophone to form an Orchestra to back the major production, "A funny thing happened on the way to the forum".

Daryl Pye on drums and Tyeson Wicks on bass guitar added a new dimension to our sound. An enjoyable year.

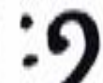

FLAT
NOTE



MUSIC DAYS

On two occasions music students and those interested in music have travelled to other schools in the wider district to make music, and friends from many schools. In term I, a group of 14 had a busy, productive day in an orchestra of 180 players and a choir of 50, and a guitar group, hosted by Matamata College. A pleasant and well organised day ended in a public performance held in the evening, showing off what we had learned during a day of workshops.

In term II, a similar programme was hosted by Otorohanga College. This time the demand was such that a 45 seater bus with Tokoroa and Putaruru students travelled to join seven other schools in orchestral and choral activities. There is a strong desire to return the hospitality and, if the personnel are available, Tokoroa High School will run a similar day in 1991.

1990 TALENT QUEST

There were people standing, overflowing into the foyer straining to hear an excellent standard of performers - solo's, duets, choirs, dance groups and bands. Even the staff created a little gem of skit and song based on school life.

The support of the audience was enthusiastic and noisy but even they quietened when "Soul Desire" harmonised.

This group of Ben Tolofua, Mathew Mauai, Sam Apulu, Mane Luatua, Sonny Tanuvasa, William Stowers, Joseph Seau, Harkness Letoa and Charlie Stowers deserved the 1st prize award from T.J's Music Centre.

They later recorded and broadcast their items on Radio Forest-land and have had many invitations to sing in the community.

The "Swing Beat Crew" - Joseph, Ina and Tere Vavia, Nerida Rawiri and Teriki Simiona - danced an energetic, slick routine to collect Second Prize.

Third Prize was split between two bands - "Soul Connection" Joey Ngati, Tunui Rau, Sonny Tanuvasa, Echo Monga, Reelerman Monga and Daniel Umax and "Chocolate Chippies" with Crossley Ngapo, Tyeson Wicks and Antony Pijacun.

Leander Wawatal won the Solo Section and Tyeson Wicks and Chung Wa Wong earned Highly Commended Prizes.

The supporting acts on the Instrumental Group, Choir and Samoan and Cook Island Groups all added to a fine evening's entertainment.



THE SINGERS OF NOTE

At last! An enthusiastic bunch of singers who had their first (shakey!) performance in assembly. They also performed at the Talent Quest before an enthusiastic noisy audience.

Gunilla Einecke helped with accompanying and it was good to have the support of singers from the staff - Mesdames Robyns, Christopherson and Woodley.

The members are: Deanne Blanchard, Jodine Capper, Mary de Ruyter, Arana Ngapo, Natasha Wisniewski, Nicola Blundell, Adeline Southwick and Mili Viita, Rowina Montgomery and Bronwyn Pope also helped with guitar accompaniment.

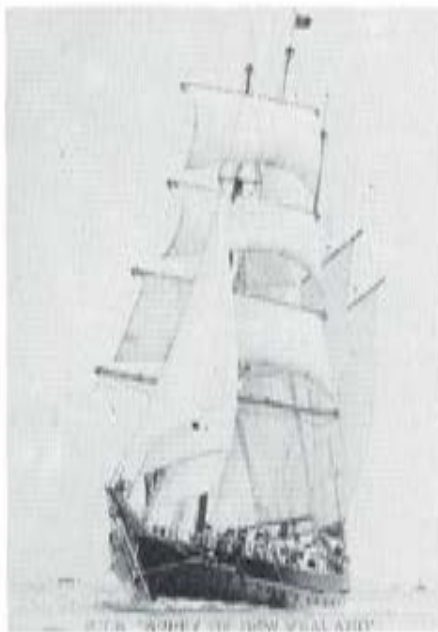

Spirit of New Zealand

Life on the ocean wave

From 17-27 August I was fortunate enough to go sailing on the Spirit of New Zealand around the Hauraki Gulf along with 39 other trainees from all around New Zealand.

We were awoken at 6.15 am each morning to get ready for our 6.30 am swim, 7.00 am was breakfast until 8.00 am when we all gathered for colours which was a meeting to discuss the days plans. Ten minutes later we were scrubbing the whole ship, inside and out. That usually took us about two hours and then we either had a lecture or set sail.

2pm was when we had lunch, which we sometimes split in half and took turns to have. We soon learnt to eat as much as we could because we sailed all afternoon without a break and stopped for tea around 8pm.

We sometimes had lectures after tea depending on what time it was and how tired we were but all had turns at night watch so some days we were awake for eighteen hours.

On the second to last day we elected our own crew and were allowed to sail the ship all by ourselves and we felt very proud of ourselves afterwards.

We motored into Auckland at 8 pm on 27 August and many tears were shed as we had become one big happy family.

Keren Smith.





LIBRARY NEWS

Sustained silent reading has meant an enormous upsurge in interest in reading, books and the library. The number of students borrowing books on a regular basis has increased dramatically. During term 2 the figures for student issue shared an increase of almost 200% on a similar period last year.

Of course students not only acquire their reading material from school sources like the library, the reading room or the classroom teacher. Their sources outside school are as varied as the number of places books are found - from home, from neighbours, from the Public Library, from the bookshop. Almost all students have managed to use one of their sources to provide themselves with something to read.

I have spent one third of the library budget on popular fiction which students enjoy reading during their silent time. I have also begun to involve students in buying books - groups of fourth formers have accompanied me to the bookshop to select books they would read. This has created such a lot of interest and enthusiasm, not only by the students involved but also from the other members in their classes, that this practice will have to continue.

I have been impressed with the variety of books that are being read - no matter what the age group. Staff and students are reading modern fiction from best seller writers like Wilbur Smith, Frederick Forsyth, Jean Auel, Virginia Andrews, teenage fiction by favourite writers like Judy Blume, Roald Dahl and Lois Lowry and fiction from famous writers like John Steinbeck, Dorris Lessing and Katherine Mansfield. Some students prefer the latest magazine on skateboarding, trucks or rugby while others read the newspaper regularly. Some students use the reading time to read their own textbooks as background for their studies and staff use the time to keep up with their professional reading.

New Zealanders are famous for their interest in books, contrary to our more public image of ourselves. Statistics show that as a population we spend more on books per head than other western countries.

From the experience at Tokoroa High School in 1990 with the introduction of sustained silent reading our staff and students will be New Zealanders who ensure the continuation of our being a nation of reading enthusiasts and lovers of good books.



LIBRARY

Back Row: Marie Swanson, Jodine Capper, Catherine Lord, Mary de Ruyter, Natasha Wisniewski.

Front Row: Rochelle Annas, Mrs Trebilcock, Mrs Brighting, Tracey Gilmour, Nicola Blundell.





TOP TEN WRITERS AMONG THE READERS

Virginia Andrews
 Jean M Avel
 Judy Blume
 Barry Crump
 Roald Dahl
 Tessa Duder
 Lois Duncan
 Stephen King
 Sweet Valley High Books
 Tolkien

Staff- Finder

EABRUPRAHLSEI ZNEKCMHEVV
 CSSYARDLEYTBRIPEYLYSBH
 SBRWKHCTUMURTTCSLEHEHZ
 NAEADREDGEUPAKIELTBAME
 GRBCCLKSREDNUASWTIALUAR
 ARRHLOKZYKLTEJHFNLRVAE
 REERAKCKAEBORTEFFRRONAT
 ITKIYTOOANRNOBICOALIOYL
 MTSSTHCFUDIRGRGBYOCCNDU
 UOETOOLLSAGBGOYOTOSHNT
 SSLONMIATLHSHZLNOLLNOEAC
 KEIPSPBVLTNSEUDWIHLLUN
 GEMHCSEANWIOKHIIVOLAFQ
 ERFEHORLOSNNHMAINLNJIHAG
 IPARWNTLWEGCMRLGLMGNWLN
 KEUSEYFASMRTEDLLIMGYEO
 CDCEDENLNCRURMMJATOSELR
 ESHNTSOCXKAHVICAMCRWLET
 LJEPOPUDSEYVIEHNSHGODAS
 RXLNTANGAROALHUSOEARODM
 TBLUETTUNXNLEGENLNTOAR
 GAEGRAHAMAGEEZHNDLIHWMA
 TSNIKTAVDNDJFPROSSERJSY

SAYINGS OF THE YEAR

- The core of education must be learning to read, acquiring the habit of reading, and appreciating the information, instruction, inspiration and pleasure that can be derived from books.
 Lord Beloff
- Education costs money, but then so does ignorance.
 Sir Claus Moser

WAITING

Here,
 The sun is setting,
 The sky is dark,
 It is the end of the day.

I am sitting on the beach,
 Alone,
 Waiting,
 Watching the sunset,
 My thoughts somewhere.

Somewhere,
 The sun is rising,
 The sky is bright,
 It is the beginning of the day.

You are sitting on the beach,
 Alone,
 Waiting,
 Watching the sunrise,
 Your thoughts here.

Ooops!
 by 
 Milli.V.



SPORT



TOKOROA HIGH SCHOOL SQUASH TEAM

TOKOROA HIGH SCHOOL FIRST XI - GIRLS HOCKEY

The Tokoroa High School First XI girls hockey team had a successful season of hockey this year with the help of their coach, Richard Taniwha and manager Jean Clayton.

The team played hard and fast with a lot of team spirit throughout the year. For many of the girls this was their first season of hockey and they should be proud of their results. 1 draw, no losses.

In winning the "B" grade and moving up to the "A" grade the girls are thankful to those who supported them.

After the great season the girls, had they also had seven rep players who showed some outstanding play, they were:

Jocelyn Carey, Rotorua under 18; Jenny Masters, Rotorua under 16; Hesper Tahau, Rotorua under 16; Judith Stevens, Rotorua under 16; Nicola Tatham, Rotorua under 16; Stacey Pollard, Rotorua under 16; Angela Taniwha, Bay of Plenty under 18.
Congratulations to all hockey girls.



GIRLS HOCKEY 1ST XI

Back Row: Arama Ngapo, Emily Trebilcock.
Middle Row: Mrs Clayton, Judith Stevens, Nicola Tatham, Kirsten Mills, Hesper Tahau, Shelley Walton, Jayd Hickey, Patricia McGregor, Mr Taniwha.
Front Row: Jenny Masters, Kelly Patridge, Angela Taniwha, Katherine Sewell, Jocelyn Carey.

This year our squash team comprising of, D.Newth, J.Cowley, M.Service, G.Seymour, J.Natua, D.Buckley, W.Newth, T.Tangimataiti, J.Gilbert, M.Fitzgerald, W.Seymour, competed in Hastings at the New Zealand Secondary Schools Squash Tournament.

We departed on Sunday morning the 12th of August, three hours later we arrived in Hastings at the Squash and Tennis Club, to be briefed on the tournament and also to find out our first round opponents. We then ventured back to our motel to get ready for our first games.

The girls were to play Taradale and the boys team came up against Southland. The results of this round were, Tokoroa girls lost to Taradale 3/2. and the boys also lost that round.

Our next round, the results were, girls won to Avondale 3/2, the boys won 4/1 to Fraser High. After a tiring day, we went back to our motel for a good night's sleep and some tea.

On Monday morning the boys were up early, while the girls slept on. When we got up and got changed, we went and played Taumarunui at Woodford house. It was a real posh school. We lost that game 4/1.

Over all the girls came runner-up in the plate. The girls went and watched the boys play Cambridge in Napier. They also lost and came runner-up in the Special Plate.

Results:
Girls: Taradale 3/2, Avondale 3/2, Taumarunui 4/1 - Runner-up for Plate.

Boys: Southland, Fraser High, Cambridge - Runner-up for Special Plate.



SQUASH

Back Row: Jade Cowley, Daniel Buckley, Dion Newth.
Front Row: Megan Fitzgerald, Wendy Newth, Jodie Gilbert, Tracy Tangi.

Athletics 1990

Although the weather made it impossible for our school athletics to take place our school representative made up for this by doing very well in both Waikato, Midlands and North Island track and field competitions.

As well as these events we have had competitors in cross country not only within our schools, around the treacherous shores of Moana Nui, but at Midland and Waikato Cross country championships. Both Midland and Waikato competitions were held in Taupo.

Achievements of note were made by all competitors who entered the Midland track and field competition as they all earned the right to compete in the Waikato secondary schools athletics championships held at Porrit stadium in Hamilton. C. Ngapo, J. Reti, O. Ryan all gained good placings with C. Ngapo and J. Reti going on to compete in the North Island championships in Hastings.



ATHLETICS

Back Row: Justine Reti, Crossley Ngapo, Brent Edwards.
Front Row: Mark Woodley, Arama Ngapo, Ollie Ryan.

Volleyball 1990

This was Tokoroa High Schools first year back in volleyball and was fraught with hazards. Not least of these was lack of opposition. To become really involved our teams had to travel considerable distances i.e. Tauranga, Hamilton and Rotorua. The senior team played their way to distinction at the start of the year by gaining good placings in two tournaments.

The newly formed junior squad will take part in these tournaments again next year and hopefully with as much success.



VOLLEYBALL

Back Row: Aukuso Aukuso, Ryan Stoble, Tino Tuao, Aaron Montgomery, Jay Cowley, Mr Mutch (Coach).
Front Row: Arryn Dawson, Matthew Maul, Andrew Sietepa, Michael Lyttle.

GOLF

During the year the Tokoroa High School Golf Team comprising of Tim Vonk, Adam Vonk, Richard Cox and Kelly Montford travelled to Inter-school Golf Tournaments at the Ngaruawahia and Te Puke golf clubs. Although facing very strong competition from opposing schools, our team managed to finish well up in the field. Both tournaments were thoroughly enjoyed by our players who are hoping for better results next year.



GOLF

Left to Right: Kelly Montford, Richard Cox, Mr Woodley, Adam Vonk, Tim Vonk.

**THIS SPACE
IS PROVIDED
TO → SPACE
BROADEN AND
ENLIGHTEN
YOUR MINDS.**

RUGBY



1ST XV

Back Row: J Walters, A Siulepa, N Hirinuku, S Tai, S Tanavasa, T Hayes, M Ferguson.
 Middle Row: R Brown, A Poi, N Wiki, R Brown, J Tarai, L Wilkinson, D Bullmore.
 Front Row: O Ryan, C Glass, C Ngapo, A Gray, J Dunn, C Tonge, M Wehipehiana.

RUGBY 1ST XV

Played 15 Games - Won 12 Games
 - Lost 3 Games
 280 Points for - 83 Points against

Losing the Tricolour was the low point of the season but the team's ability to rise again and beat some of the better teams in the competition was one of the many strengths that the first XV of 1990 possessed.

The team was sprinkled with youth and experience but moulded together well with both the backs and forwards complimenting each other.

The game plan was to play an expansive game, utilising the speed out wide with Crossley Ngapo being the major contributor. Olly Ryan was the strength in the mid-field with his very strong running. Tommy Hayes directed play from 1st 5/8 and was the team's goal kicker and could possibly be the team's highest points scorer.

Top Try Scorer is between Olly Ryan and Crossley Ngapo. The forwards were led by Captain Arron Gray who played consistent rugby all year and never let his team down. Caillin Tonge, diminutive open side flanker, again showed that you don't have to be a giant to gain higher honours as he was named in the NZ Under 16 and Waikato Secondary School Squads.

Nga Hirinuku and Nicky Wiki were very solid up front and with the experience of Jemarl Dunn at hooker provided opposition teams with a very awesome task.

Colin Glass was again the team's most honest toiler, always giving his 100%. Junior Tarai and Rewiti Brown with a little more fitness could be a big worry to other locks next year. Stacy Tai, the thinker in the team was invaluable in the tight and could well be in line for higher honours in the future.

All round the team played some very attractive rugby and with the major number of team members returning in 1991 the 1st XV could very well win the Tricolour Trophy.

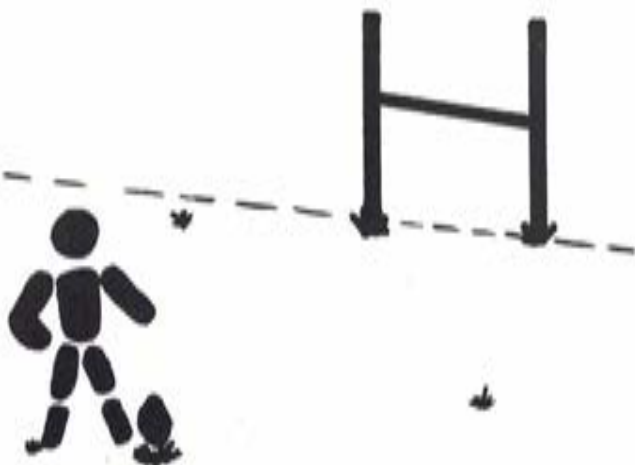

LEAGUE

Back Row: H Ngati, P Martin, D Gabriel, M Draper, M Verhaegh, J Clark.
 Front Row: J Dunn, B Tereu, D Tereu (Captain), D Lepa, M Marsters, A Gray (Coach).

TOKOROA HIGH LEAGUE REPORT

This year's Tokoroa High League team was slightly weakened compared to last year, but still had the backbone of last year's squad.

In the first game against Hillcrest, the Tokoroa boys were not overawed and the forwards were able to come up with some big hits. People in the crowd said we were unlucky to lose by 22-0.

The second game, against eventual winners Fairfield, was an even one despite the 32-0 score. Again the forwards impressed.

In the final game, against Hamilton Boys, Malcolm Masters unleashed his potential with two brilliant tries, both set up by the forwards. Tokoroa silenced its critics by winning the game 18-8. Forward of the tournament was an inspirational captain, Dean Tereu, while back of the tournament was Dominic Lepa, followed closely by the rest.

TOKOROA HIGH SCHOOL GIRLS SOCCER FIRST XI

Playing in the well established Girls Waikato Soccer League was a great challenge for both the team and coach. Starting from scratch, the girls gained skill, knowledge and fitness through out the season.

The opposition was tough and we lost our first four matches. However, nobody gave up. Everybody continued to turn up to training and the skill level slowly developed. Eventually the teams psych began to change, and instead of expecting to loose we were looking for draws and even wins. Our final position in the league was about half way up.

Helen Mace captained the team and Shelly Guyton was vice Captain.

Next year we are expecting to gain success, and our training will begin in February. Every member of the team was a star in her own way, and so no individuals will be singled out.

A special thanks to Mr Griffiths for coaching, organising and putting up with us. Also thanks to the parents for providing much needed transport.

PS Bye Bye to FLUFFY



GIRLS SOCCER 1ST XI

Back Row: Rachael Newfield, Shelley Mischewski, Kylie Tatham, Kerry Cochrane, Michelle Farrell, Renn Erceg, Debbie Cameron, Natalie Kalo.
Front Row: Megan Jones, Rachael Erskine-Shaw, Helen Mace, Shelly Guyton, Tania Burke.

TOKOROA HIGH SCHOOL 1ST XI SOCCER - BOYS

The season of 1990, the second for the school in the Waikato Secondary School's competition, started unimpressively - we lost all our grading matches. But the team knew they could do better. They trained hard, developed new skills, gained confidence in their own abilities and began to show what they were capable of. From the bottom position in the first round they went on to win the second round to finish second overall.

Much of this accelerated improvement was due to the dedication and coaching of Mr C. MacAdam. The support of parents has also played an important part in the teams success. Thank you to them all

Though far from National League Status in their borrowed strips, many of the boys went on to age group representation and hopefully will go on to make soccer, more

prominent sport in the school.



SOCCER 1ST XI

Back Row: Oliver Webb, Tim Vonk, Allies Edge, Ross Gee, Stacey Thompson, Tony Herlihy, Adrian Baxter, Mrs Kerbers.
Front Row: Adam Vonk, Kelly Montford, Desmond Hoeflich, Alan Togle, Craig Treanor.
Absent: Brendon Brown, Adrian Tocker.

Cycling

Cycling is a sport that has leapt into the limelight this year. Following on from the success of New Zealand cyclists at the Commonwealth Games, a small group of students have had comparable success at High School levels. The amazing run of great performances started early in the year when the school entered a team in the Waikato Bay of Plenty Mountain Bike Championships.

Results were: Junior Boys: 1st Scott Guyton, 2nd Micheal Butler, 4th Mark Phillips, 5th Nathan Whale.

This secured a first team place and best preformal team.

Later in the year, the Waikato Bay of Plenty teams time trial championships saw the team of Scott Guyton, Mark Phillips, Nathan Whale, Paul Montford finished a creditable.



CYCLING

Left to Right: Mark Phillips, Micheal Butler, Scott Guyton, Nathan Whale, Carson Arrol, Paul Montford, Henry Hale.

NETBALL

SENIOR A NETBALL



This year the Senior A netball team consisted of six new members, Kura and Katherine being the only two previous members.

The season started off with a bang, the team trying to combine skills that were hidden in all of us. Most of the ideas we put across went into our trainings, and we all helped each other out in areas that we weren't very good at.

For the third time in a row, Tokoroa High School Senior A made the premier grade; playing top teams such as Excels I and Spartans, but the girls kept their wits about them and took this all in their stride.

During the season we had a close encounter with Forest View A, losing to them 17-16. Throughout the season, Forest View was our main opposition. The girls were determined to beat them, so was our coach, Vanessa Dawson, and Mama Maea. When the final clash came before us the whole team went out with determination. We had plenty of supporters and the game in the last five minutes went goal for goal. In the end we won 20-19. Many of the girls were versatile in their positions. Rhonda at GD then Centre, Kim at GS to GD or GK, Kathrine and Kura made sure we knew what we had to do, always encouraging and backing up. Congratulations to Tanya for getting the most improved player of the season.

Travelling to Auckland to see the New Zealand versus Jamaica game was an inspiring event for the girls. Meeting the New Zealand team and also seeing an ex pupil, Pania Papa, made our trip one we would never forget.

Many thanks go out to our supporters, especially Mr and Mrs Barbarich and Mr Sommerville. To Mrs Vanessa Dawson, who believed in our team and gave up precious time to coach us instead of spending time with her family - Thank you.

The girls would also like to thank the Dawson family for allowing Vanessa to attend so many practices. We would like to wish Vanessa and her family all the best for the future in Tauranga.

Last but not least, the whole team would like to thank Mama Maea. Thank you for supporting our team and always encouraging the girls. Always being there when we needed someone to talk to. Although Mama was unable to be at the courts every Saturday, we knew she was behind us. Our sympathy goes out to our Mama and her family on the death of Papa Maea.

To the girls who are travelling to Australia next year - good luck, to the up and coming Senior A netballers - good luck in your netball season.

Ngawini Poumako



SENIOR A

Back Row: Katherine Barbarich, Rhonda Hale, Pilar Tahau, Kura Glassie, Mariana Cripps.

Front Row: Tanya Tetava, Vanessa Dawson (Coach), Ngawini Poumako (Captain).

Absent: Kim Blomfield.

Another season of Netball gone by with its successes and failures. Many sincere thanks to our dedicated, tireless and committed coaches who devoted their time, energy and talents to coach the girls. Words cannot express how I and the school appreciate your services. A special thank you to all our teacher supporters, especially Mr Roger Sommerville, parents and students who came along every Saturday, rain or fine. To Mrs Ann Machen - for the umpiring classes and also for visiting us on tournaments. A sincere thank you.

Mrs Vanessa Dawson at our break-up party said - "This years High School A Team had really made my year in Netball. Your friendliness, caring and sharing, willingness to help one another, co-operation and most important of all, your high respect for me. Listening and applying the skills taught skilfully when playing. All the games you played were in true sportsman spirit. Win or Lose."

Ngawini in her capacity as captain performed her duties well. Kura along with Katherine as long service caps in the A team - gave helpful hands to the girls. To everyone in the A team this year for your effort and dedication.

The A team improved towards the end of the season and was 3rd in the C championship competition in the Premier Grade. CONGRATULATIONS for that extra effort.

netballers

CONGRATULATIONS to the following girls for being chosen into the MIDLANDS REP TEAMS. It is the highest honour any player can attain at the High School level.

UNDER 18

Pilar Tahau
Kim Blomfield
Rhonda Hale
Treena Tetava - pulled out due to school commitment

UNDER 16

Kirsty Watene
Moana Kilikoro
Katheryn Petero

UNDER 21

Sharie Gray

TOKOROA REPS:

UNDER 18

Ngawini Poumako
Katherine Barbarich
Mirlande Ford

UNDER 16

Aroha Riki
Martha Rikiau
Catherine Lepa
Kara Ackerman
Lisa Paraku
Moe Putai

OPENING DAY

4B team won opening day.
Senior Blue won closing day
4A and 3A only missed out winning Secondary School Tournament in Hamilton by losing one game.
Senior Green and 4 Purple won a one day tournament.
To all the girls who dedicated their time and energy into the game, I say thank you - Sarah Mace and other girls who are leaving school, I say thank you for your services to Netball at our school. Haere ra - God bless.
Mama Maea - Teacher in charge of Netball.



SENIOR B

Back Row: Apil Rota, Sharee Gray.
Front Row: Lisa Paraku, Sarah Mace (Captain), Treena Tetava.
Absent: Mirlande Ford.



SENIOR RED

Back Row: Treena Tetava, Kylie Dewar, Kylie Rowe.
Front Row: Fiona Wong, Mellanie Phillips (Captain), Zania Easten.



GREEN

Back Row: Katherine Barbarich, Davina Edwards, Teokotal Tarai, Kerry Shuler, Teremoana Vavia.
Front Row: Bernie McGregor, Ariana McRoberts (Captain), Debbie Tanoa.
Absent: Mingi Temarama.



5A

Back Row: Kara Ackerman, Moe Putai, Sheree Redinger.
Front Row: Wiki Papa, Katherine Lepa (Captain).
Absent: Moana Kilikoro, Michelle Campbell, Chelsea Tahau.



5 BLUE

Back Row: Jodie Mear, Kerry Kaloke, Cynthia Dean.
Front Row: Jaslene Tereu, Ruth Tuakana (Captain), Lyncosa Butler.



4 PURPLE

Back Row: Teremoana Vavia (Coach), Stephanie Steel, Lania Takari, Juanita Allan, Lucilla Rainsfield, Tashlyn Jones.
Front Row: Deanne Blanchard, Antonina Horn, Roselyn Dehar.



4B

Back Row: Carol Kemp, Raewyn McRoberts, Martha Rikiau, Aroha Riki, Awhina Te Hiko, Kristie Watene (Captain), Kiri McLean.
Absent: Ngawai Wilkinson.



3A

Back Row: Ngawini Poumako (Coach), Melissa Wilson, Nani Makiakama, Stephanie Poko.
Front Row: Wendy Machen, Kathryn Petero (Captain), Louise Hewitt.



3B

Back Row: Adra Dehar, Alaina Trickey, Hayley Royal, Ritiana Mahanga.
Front Row: Amanda Gordon, Nerida Rawiri (Captain), Margaret Matthews.



3 WHITE

Back Row: Maria Gernhoefer, Pauline Talki, Lisa Thompson, Taria Paul.
Front Row: Melissa Stevenson, Julie Paul, Janice Bell.



**Pania Papa scores
ultimate in netball**

JUDO CHAMPION AARON MONTGOMERY

New Zealand Championships
1st Open weight Intermediate
1st Over 71kg Intermediate
3rd Under 78 kg Junior Men

New Zealand Secondary School Championships
1st Open weight
1st Over 78 kg

Oceania Judo Championships in Tahiti
1st Over 78 kg Under 17
2nd Under 86 kg Under 21

World Youth Tournament
1st Over 78 kg Under 17
1st Open weight Under 17
1st Under 86 kg senior men
1st Under 17 teams fight New Zealand

New Zealand Grade Champion
1st Age group
1st Open

New Zealand Championships
1st Open weight Intermediate
1st Over 71 kg Intermediate
3rd Under 78 kg Intermediate

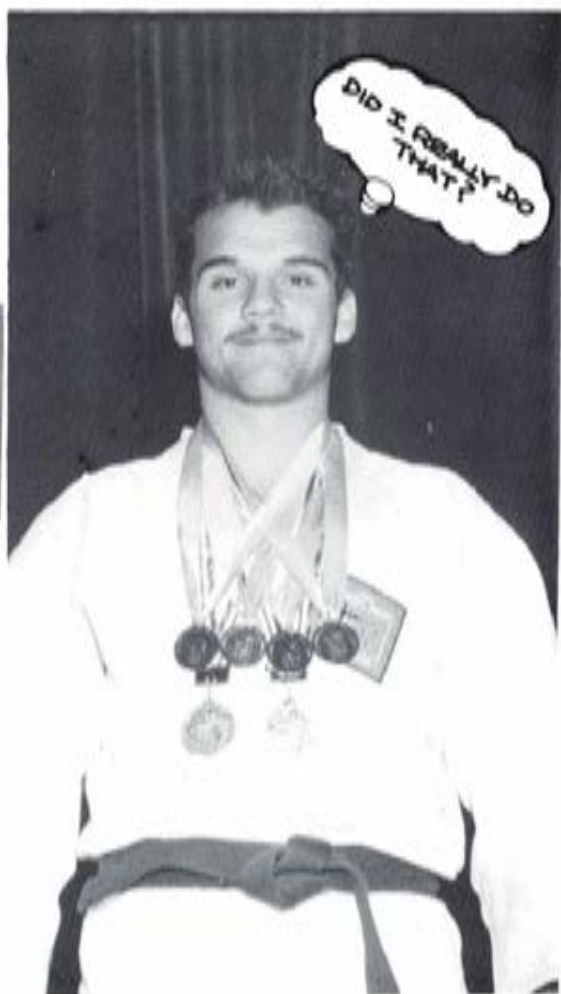

LOOKING ALL AT THE DETAILS

CAILLIN TONGE

- 1988 Waikato Under 15s
- 1989 Waikato 16s
Northern Regions 16s
North Island
Bay Touch Secondary Schools
- 1990 New Zealand 17s Rugby
All Stars Team
Waikato Secondary
Bay of Plenty Rugby League
New Zealand League 17s
Bay Touch Secondary Schools

CROSSLEY NGAPO

Mid Islands

First 100 metres
First 200 metres
First Long Jump

Waikato Champs -

First 100 metres
Second 200 metres
Second Long Jump

Waikato Secondary School Champs -

Second 100 metres
First 200 metres
Second Long Jump

North Island Secondary Schools Champs -

Second Long Jump

New Zealand Championship -

4 x 100 metres Relay Bronze

Crossley holds the record for the Waikato Championship long jump and is also competing in December at the New Zealand Secondary Schools Champs in Wellington for 1990. Crossley is also a member of the First IV and played for the King Country under 18s with two other students from T.H.S, Sonny Tanuvasa and Tommy Hayes.



Clayton Blundell. Archery

N.Z. Junior team. 1989-90
2 Gold medals,
Indoor and Outdoor.

Gerald Seymour. Squash.

Under 13 N.Z. Champion. 1988-89.
Under 15 N.Z. Champion. 1990.
Involved in N.Z. Development Squad.
B. 2. Grade.
Has a chance to travel overseas with team.

Dougal Devantier
2nd NZ Speed Shooting
Championship Tyro Grade



DRAMA GROUP



Members of the Tokoroa High School drama group hit the road recently with the area's Employment Centre staff in a bid to encourage more employers to the centre's services. The group targeted employers at Mangakino, Putaruru, Tirau, Tokoroa and Atiamuri. For four nights in May and June the group polished up their acting skills to perform skits about employers and employees' roles in the work force. Themes included, 'Women can do Anything, Good and Bad Employers and How to Cope with Good or Bad employees. Back row (left to right): Adrian Baxter, Karen Nemes, Ian Grant. Middle: Mark Ward, Samantha Kay, Karina Wiley. Front: Emily Trebilcock, Arama Ngapo, James Swanson.

**FOR MY MOTHER
Mo aku Mama**

For what you gave
 For what you took
 For what you taught
 For what you learnt
 Thank you
 The woman I am
 Is the woman you made me
 My mistakes are your shame
 But my successes are your pride
 In your eyes I am your child
 And shall always be
 In my eyes you are my mother
 And you will always be
 Our friendship has grown deep
 Into the earth
 Our foundations are strong
 Thank you
 Time has passed by
 Time never stands still
 And we all have changed
 With age, wisdom and truth
 We are strong as a family
 And courageous alone
 Thank you
 Let us never be too vain to say
 I love you
 Let us never be too blind to say
 We care
 To the ones we care about
 Life is too short, for us to forget
 The most precious people in our lives
 So I say goodbye
 As I pass on to a new step in my life
 Motherhood
 And I hope I am as good a parent as you have been
 To me.
 The woman I am is the woman you made
 Thank you.

Ko te aroha nunui o nga mea katoa
 Ko te aroha o te mama.

By Arama Ngapo



I didn't do it
 Ange! ↑



CAMPS

Form 7 Leadership Camp

In the distant surrounds of the great Papa O Te Aroha marae, a small group of brave young students prepare to take part in a brutal and gruelling four day leadership programme. A programme led by two merciless, unsparring men...

Actually, this year's leadership camp proved to be one of learning, friendship, and unlimited fun, with a dash of hard work thrown in.

With the particular venue of Papa O Te Aroha, what better way to commence the week than with a traditional powhiri. This very impressive welcome did nicely to prepare us for the mildly cultural few days ahead.

The first night served as a "get to know you" period where we were briefed on the camp's plan of action and warned about the tasks which lay ahead, but after the introductions were over it was time to knuckle down and have some serious fun.

Each morning an attempt was made to awaken us at the unearthly hour of 6.00 am, after which time we were made to partake in a very punishing and strenuous session of ...Ugh... exercisell! You can forget "Aerobics Oz Style" - Henare Johns and Wendon Hutchins are taking the world by storm.

After a quick (but delicious) two or three course breakfast, it's time to do chores before getting stuck into a variety of thought provoking, fun, leadership building, group activities. These activities included such things as Moon Wreck, Murder, Static Pyramids and the totally professional fashion show (all fabrics courtesy of last month's newspapers!).

Each of these activities was lead by a member of the camp's "family", and after each task the student was evaluated for his or her performance. The criticism was of course positive, and helped to determine where each of us could strengthen our leadership skills.

By the end of the week we had all gained at least eight or nine pounds, were very tired, and had the knowledge that anyone is capable of leading a group. We had learnt how to work together with others, how to cope with conflict, and the importance of compromise.

A great time was had by all, but I think the highlight of the camp has to be Henare and Wendon doing their version of the classic "Swing Low". Who'd believe that these two guys are actually Tokoroa High School teachers!!

It will be a long time before anything so hilarious happens again, and I'm sure next year's camp will be just as much fun, if not more so...

GAEL PRYCE



1990 SKI EXPERIENCE

What a great experience it was!

We left for Whakapapa in the early morning, around 6am. Mrs Brunton was in charge, she had organised the group of young enthusiastic skiers well.

We arrived on schedule, clad in our Kinleith yellows and joined the queue for the Shuttle.

We eventually reached the slopes. There was a rush to get boots and poles before going to tackle the beginner slope.

Most of the day was spent there. The hours skiing were great fun, after falling over a few times it became easier (for most anyway).

The day passed quickly, with lots of laughs and moans. Then the clouds and our bodies warned us, it was time to go.

The day cooled down and before we knew it, the bus was setting off home. We stopped for supplies, heard a few jokes and the bus pulled up in the bus bay.

Everyone went home after a fabulous experience.

TRAMPING CAMP



Yes, well, tramping camp. The hardships, the pain, the trials. The fun, sights, people and the achievements. The first day was long and cold, with one of the strongest coldest winds imaginable. And the sleet and rain didn't help any. As well as climbing over wet, slippery rocks, up mud banks and through swollen rivers, we just seemed

to keep going up and up. The view was good though. It took about 6-8 hours for most people to get to the Maungaturuturu hut and we arrived in darkness, cold, wet and tired.

The second day was paradise in comparison. It was sunny and it snowed overnight. We tramped for 5 hours to the next hut and we saw (and climbed over) some magnificent scenery. We got to the next hut early and had plenty of time to relax and socialise. This hut was like heaven compared to the first and we all appreciated it. The third day was the walk into Ohakune to catch the bus to Hamilton.

To get to Ohakune we had to walk 12km down a road. Yep, that damn road, how could anyone forget it? It seemed endless and hurt your feet beyond belief.

We finally reached Ohakune and waited for the bus. We then proceeded up to Hamilton for a few hours then went back to Tokoroa. A tired bunch, each with his/her own memories, feelings and achievements created by the camp.

Paul Martin

CYCLING CAMP



At 8.30am on Wednesday morning, 15 cyclists in their spunky helmets set off for Taupo. Mrs Graham in the support vehicle and Mr Mutch bringing up the rear on his mountain bike. Down the hill to the Whakamaru shops, then down the back roads to Taupo. Up hills, more hills, and even more hills, with just a few people walking up. A hot swim after tea helped the sore muscles, and we froze sleeping in tents at Taupo.

Taupo to Rotorua was the longest day and even more so for a few who biked 30km extra thanks to Larn. Along some quite busy roads we nearly lost a few cyclists as the logging trucks roared past.

MacDonalds for afternoon tea, then the guys cooked tea again. Another hot swim. At night we didn't miss out on the home comforts. Watching TV and hot showers.

By the next morning it was getting painful to sit on a bike seat and legs were sore as soon as pedalling began. Through the streets of Rotorua went a trail of cyclists in helmets and colourful clothing.

After 20km or so we were nearly home. Over another big hill, the Mamaku's, through Putaruru and after lunch was the final test. The steep hill on Old Taupo Road just a few kilometres from Tokoroa. Those with will power rode up, but some walked.

Finally we were home. We had survived and had had a lot of fun.

Sarah Mace



WATER SKIING CAMP



We arrived at the Whakamaru Water Skiing club on a somewhat miserable day. The sky was cloudy and the wind would not cease to blow. Everyone was excited, water skiing was a new challenge to us all.

The guys put on a brave face and nominated to go first. The expressions upon their faces showed that this took a lot of concentration. Managing to get up was a mission that seemed almost impossible, especially for Jodi.

Ollie showed some skills by advancing himself to one ski, but Dion had the most skills out of us all, by staying up on one ski the longest. Everyone would rise and shine at about 7.30am or sometimes earlier (the guys), and get straight into wetsuits then hit the water. Mrs Brunton gave us some tips on when the water was best to ski. Mr Brunton alias Gary always encouraged the girls. He also spent more time with us!

All the girls started on the bar, we had to have a confident stance then Gary would let us proceed to the rope. Raewyn showed talent by skiing around half the bay, while the rest of us gave encouragement from the boat. When the water became too rough, we would go into the club rooms and have a hot drink. We would also talk about embarrassing or exciting moments that we had experienced that day. The men that were helping would video tape us and that was our entertainment for the night. Everyone would crack jokes about all the stupid things people would do, or just how stupid they looked. During Gary's 'excellent' video taping skills, Hiro would be heard singing something in Japanese.

On our last day everyone was up extra bright and early, eager to have a last ski. The sky was over clouded, but

that didn't stop anyone. Mrs Brunton was running around like a mad hen, trying to make sure that everyone had their gear together.

General thoughts that came from the people on the water skiing camp, were: 'this beats cycling and tramping anyday'. Everyone wanted to stay, but a shower, a comfortable bed and a TV were some of the home comforts we all missed.

Ngawini Poumako

Fourth Form Camps

Pain! Hurt! Agony! Descriptive terms used to explain why jobs weren't done.

"Put that possum back where you got it!"

"Sorry boys, it's illegal to use gellignite to fish for trout!"

Attempts by staff to keep pupils in line!

Fourth form camp at Wiahaha Marae. An exceptional facility offering to students an abundance of opportunities within a very confined area, rock climbing, canoeing, tramping, fishing, snorkeling and river work. All and more took place within metres of each other. The students performed admirably and showed determination to finish tasks and experience new things. Going for a walk in the bush at night with no lights may not be your idea of a great time but all campgoers gave this a go as well as following a Burma string trail in the bush at night.

Our special thanks must go to the members of staff who went to camp and ensured the smooth, safe running of all activities. Also we need to thank parents for their support. Possibly the biggest effort of all was made by Charlie MacAdam, our Canadian import, who supervised three camps in a row and still came back smiling.

The tramp to the waterfall proved challenging to all and was, "conquered by the thronging masses." That was how they felt when we got there, they were not so pleased to be told that the way in was also the way out.

Camp food was great, pupils produced food fit for a king and regular cries of "What is that glop?" rang from the hillsides. No one went hungry and the last breakfasts were huge as people tried to reduce to a minimum the amount they had to carry back up "THE HILL".



LANGUAGE CAMP Ngaruawahia

End of March 1990
Approximately 120 High School
Students from the Waikato

Choice! Heaps of nice girls, yummy food, I think I gained 3 kilos (Gard)

...What is frustration - listening to jokes through the walls and never getting the punchline...

We found out some strange customs: like Mili and Gunilla swimming at 7am in the morning wearing socks with TOES. Great, huge cockroaches in guys' toilets (Melanie) ... What were you doing in the guys' toilets Melanie? (Miche)

...Not realising that the shower facilities were UNISEX - some face to face confrontation with unsuspecting young man caused...

...Great! It was new to me! We have nothing like it in Finland. I really enjoyed the camp. It was quite hard to try to speak German and French and to get understood! (Mili)

...The only way to survive was being able to indulge ourselves in the cafeteria with our 'play money' - Moros and chips galore...

...The only meal identifiable was the typical Maori roast, fish'n'chips from down the road...

...Camp meals were interesting. All introduced in a foreign language. Not always could we figure out what it was. Maori, Japanese, German and French cooks produced the most delicious native dishes...

...Breakfast was the highlight. The only meal we recognised...

...Lots of local talent displayed during the concert, hilarious skits, no one got Tok High jokes...

...Tu's jokes, what happened to the sheep that was stuck in the tree? It died!! What happened to the sheep that came down from the tree? It ran away!!

Languages represented were: Maori, French, Russian, Japanese, Norwegian, Spanish, Finnish, German and Italian. International bonding was achieved through friendship, smiles, fun, laughs and FOOD.



4th FORM CAMPS



"You Can Check Out Anytime You Like, But You Can Never Leave"

FORM 7 ~ 1990



YEAR FIVE (FORM 7)

Back Row: Paul Martin, Malcom Masters, Dean Tereu, Dominic Lepa, Dion Newth, Ollie Ryan, Mark Draper, Brent Edwards, Denny Govender, Kimberley Rothwell, Irene Yardley, Rebecca Lau, Lorna Wallace.

Middle Row: Karen Beets, Lisa Paget, Carroll Fargher, Gael Pryce, Jason Joe, Ella Hoefflich, Adam Ellis, Sarah Mace, Michaela Nill, Larn Wilkinson, Jason King, Matilda Ropiha, Monique Portegys, Kylie Bryers, Mavis Poumako, Andrea Baird.

Front Row: Arron Gray, Colin Glass, Patrick Stevenson, Jeremy Clark, Matthew Verhaegh, Tanya Tetava, Ruth Newfield, Raewyn Bates, Ngawini Poumako, Karen Krause, Grace Scott, Debbie Keyte, Janine Welch, Tina Singh, Jodi Gilbert, Angelina Janssen.

NAME: Kimbo Rothwell
WHO LOVES: Big Macs, candlelit rooms, and JO!!
WHO HATES: People against Big Macs, clucky check-out chicks, dribbling babies.
WHO FEARS: A world shortage of Big Macs, waking up one morning and finding my head's turned into a Big Mac, Having a baby who dribbles excessively.
WHO IS GOING: To the nearest Golden Arches.
QUOTE: A Big Mac is better than a kick in the teeth!

NAME: Raewyn Bates
WHO LOVES: My room, A', Slow Jams
WHO HATES: Being hassled, being FAT!
WHO FEARS: Size 14, Being all alone
WHO IS GOING: To get some AIR Jordans, to get it right somehow
QUOTE: "Consolation can be found in what you deem best ... as a friend!"

NAME: Patrick
SON OF: Short, adorable, modest, obsessive
LOVER OF: Kay and Peter
WHO FEELS: What can never come back
WHO NEEDS: Everyone knows something I don't
WHO GIVES: A red Ferrari and a road to Paradise
WHO FEARS: A damn about the deterioration of our planet
WHO WOULD: Werewolves
WHO WOULD: Like to be the worm inside a Tequila bottle

NAME: Ella Hoefflich
WHO LOVES: My Room
WHO HATES: Kill joys and the menstruation blues
WHO FEARS: An unsatisfied, non-remembrance apocalypse with no palingenesis
WHO IS GOING: Au-Rivoir!!!
QUOTE: Art is the most intense mode of individualism the world has knownt (wow, really deep man!!)

NAME: Karen Krause
WHO LOVES: Elvis, Haitian Folkdancing, Sa moan Cricket, Tokoroa, Jazz
WHO HATES: Teeny Bopper Stars, Plastic People wars, Kids dying, NEIGHBOURS
WHO FEARS: The ozone hole, Jenny Craig's secret, police, wars
WHO IS GOING: Fai te tulaga Lona tolu o A' oa' ogall! God willing!
QUOTE: 'Que serah serah'





NAME: Alias 'Laurels'
 WHO LOVES: MOCKING *Try Hards; who love themselves
 WHO HATES: Try hards that love themselves
 WHO FEARS: JUDGEMENT DAY!!!!
 WHO IS GOING: TO BE HERE IN THE SECOND COMING!!! SEE YA THERE....
 QUOTE: DREAM A DREAM AND THEN FULFIL IT!!!!!!

NAME: Crossley (B.L.N.) Ngapo
 WHO LOVES: His Mum, Dad and M.C. Cripps
 WHO HATES: Nobody
 WHO FEARS: Nothing
 WHO IS GOING: To be a star remembered forever.

NAME: Paul Martin
 WHO LOVES: Dreamer, Mysterious, Shadow The Sun, Moon, Laughter, Tears and dreams of the past
 WHO FEELS: That to much emphasis is put on success and money and not enough on enjoyment
 WHO FEARS: Losing my individuality just to fit in with the crowd!
 WHO IS GOING: Where-ever the wind takes me
 QUOTE: Sometimes it is better to dream than face reality

NAME: Lorna Wallace
 WHO LOVES: Custard squares, elephants, Life
 WHO HATES: Cruelty to animals, deceit, people who can understand calculus
 WHO FEARS: World war, the day when there is nothing to laugh about
 WHO IS GOING: Wherever my dreams take me - first stop the world famous prestigious law school of Waikato University!!
 QUOTE: Laughter is the best medicine

NAME: Mevis Poumako
 WHO LOVES: To sleep
 WHO HATES: To strain herself
 WHO FEARS: Work!
 WHO IS GOING: To get out of Tok!!
 QUOTE: "You made your bed!! ... Lie in it!!"

NAME: Rebecca Lau
 WHO LOVES: Sunbathing while listening to U2, with an ice-cold drink in my hand.
 WHO HATES: Clouds which get in the way of my tan!
 WHO IS GOING: to Waikiki Beach, OAHU, HAWAII
 QUOTE: Grab the sunnies and tinnies, and Rattle and hum, in the sun. p.s. Don't forget the coppertone!

NAME: Tina Singh
 WHO LOVES: Splad, Summertime, 'Paris' and Books
 WHO HATES: Homework and Physical Exertion
 WHO FEARS: Failure and being alone
 WHO IS GOING: Where children under five see nothing but the truth
 QUOTE: 'As he knew not what to say, he swore'. -Byron-

➔ COME ON!!!

NAME: Michaela Nill
 WHO LOVES: Gossip, Food, My dog.
 WHO HATES: People who gossip, Pineapple, People who tell only half the story
 WHO FEARS: Running out of gossip, going bald, Walking out of Alberico's
 WHO IS GOING: To gossip, To Grow, To be a SHRINK!
 QUOTE: Trust me, I know what I'm saying.

← Boxes!

NAME: Ngawini Alias NGA
 WHO LOVES: Mocking Lam!!
 WHO HATES: Guys who think they are better than girls, especially J.W!!!
 WHO FEARS: SHRINKING EVEN MORE!!!!
 WHO IS GOING: To GROW and make you all eat your words!!!
 QUOTE: "GREAT THINGS COME IN SMALL else who calls me everyone SHORT!!)

NAME: Jodi Gilbert
 WHO LOVES: The Smiths, constant supplies of fish, the Smurfs
 WHO HATES: Heavy Metal, non socialites, Azrial
 WHO FEARS: Going insane, 'JAWS', Gargamel
 WHO IS GOING: To the Vogue editing office, IN SANE
 QUOTE: "I'm surrounded by idiots"

With lines joining them!



Run run!

It's actually a very good exhaust system!

NAME: Janine
 WHO LOVES: Potato chips, Coca-cola
 WHO HATES: Fish, Flies
 WHO FEARS: Lorna's fringe, Debbie's driving
 WHO IS GOING: To a finger-painting heaven
 QUOTE: Love yourself in case no-one else does!

NAME: Mariana 'MANA'
 WHO LOVES: C.N.
 WHO HATES: Going to class
 WHO FEARS: 'No-one'
 WHO IS GOING: To win LOTTO
 QUOTE: Support the police, beat yourself up

NAME: Monique Portegys
 WHO LOVES: Heavy Metal, the idea of world peace
 WHO HATES: Ignorance, Dance Music and crew cuts
 WHO FEARS: Failure, flares coming back into fashion and dance music taking over the world.
 WHO IS GOING: To join the Valkyrie and ride over battle fields claiming dead heroes to eternally dwell in Valhalla with Odin
 QUOTE: A tomb now suffices many for whom the world was not sufficient

NAME: Debbie Keyte
 WHO LOVES: Parties, Food
 WHO HATES: New Kids On The Block, Check-out chicks
 WHO FEARS: Lorna's Laugh, going insane
 WHO IS GOING: to Zoobilee Zoo
 QUOTES: Men should be like dogs, tied up.



NAME: Carroll
 WHO LOVES: Life, my mini, hairspray
 WHO HATES: No-one, shortness, fish
 WHO FEARS: Heights, forgetting the hairdryer, Traffic officers
 WHO IS GOING: Somewhere other than Tokoroa, To be tall, Skinny, blonde and successful
 QUOTE: It's what's on the outside that counts, it's what's on the inside that matters, I know.
 SURNAME: Fargher

NAME: Gael
 WHO LOVES: Food, Sleep and Garfields whiskers
 WHO HATES: Ronald McDonalds colour scheme, Jellymeat
 WHO FEARS: Being squashed by Big Foot
 WHO IS GOING: To figure out where I'm going
 QUOTE: 'Don't do anything I wouldn't do and if you do don't get caught!!'

NAME: 'Chaela
 WHO LOVES: The 'Sulky' one
 WHO HATES: Being lonely
 WHO FEARS: Chris's 'sulks'
 WHO IS GOING: Onwards
 QUOTE: It's nice to be important but it's important to be nice.



NAME: Kylie Bryers
 WHO LOVES: Piglets, Tiltan, Whales, Globes
 WHO HATES: Physical exertion and people solely concerned with money
 WHO FEARS: Being stuck in New Zealand all her life
 WHO IS GOING: Everywhere in the Northern Hemisphere
 QUOTE: Anything worth having is a thing worth cheating for

NAME: Karen Beets
 WHO LOVES: Ice-cream
 WHO HATES: Pierced noses
 WHO FEARS: Sharks
 WHO IS GOING: AWAY
 QUOTE: Everyone sees only what they want to see

NAME: Chris
 WHO LOVES: Guess who?
 WHO FEARS: Staying in Tokoroa
 WHO HATES: Trying to answer these questions
 WHO IS GOING: Fast, me and Chaely, in our car, from our past
 QUOTE: -1990- The year of red Tab Jeans Dark Blue, rolled up, wide seams ...

NAME: Ruth
 WHO LOVES: Friends, Freedom and funtimes and her British Knights!
 WHO HATES: Cleaning her room.
 WHO FEARS: Giving Kim Blomfield driving lessons
 WHO IS GOING: To prove Andrea wrong and win our bet!!!
 QUOTE: If you can imagine it
 You can achieve it
 If you can dream it
 You can become it!

NAME: Tutanoa (Toots)
 WHO LOVES: Being a pain in the butt! Being a truant! Dwayne Wayne!
 WHO HATES: Being shutdown, fogged up glasses, pep-talks
 WHO FEARS: Being in Carol and Michaela's English class again!, unemploy ment, living at home forever
 WHO IS GOING: To be witty one day legalise truancy, to invent window wipers for glasses
 QUOTE: The earth rotates untold times per second and we humans are but a sick race taking a dizzy ride. SHOCKING!!
 SURNAME: Solomon

NAME: Larn
 WHO LOVES: Music, Leather and 'Batman'
 WHO HATES: Losing to Ngawini (a rare occa sion)!
 WHO FEARS: fluths pencilcase and Andrea's jokes!!
 WHO IS GOING: to someday live in Hawaii.
 QUOTES: "He who lives in the fast lane finds pleasure, but it is he who lives in the middle lane that finds life."

NAME: Angelina Janssen
 LOVER OF: Almond Mars bars, straight hair
 WHO HATES: Boatshoes, Bimbos, staying home on Saturday nights
 WHO FEARS: Kylie's singing in Bio, Jodi's Jokes, Curly hair
 WHO IS GOING: Under the sea to the octopuses, garden in the shade
 QUOTE: I'm not drunk just on a natural high

A typical week of a Senior



monday



tuesday



wednesday



thursday



friday



Saturday



sunday

1990 ACADEMIC AND SPORTS AWARDS FORMS 5, 6 AND 7

JOINT DUX OF THE SCHOOL Form Seven:

- Sarah Mace : 1st Biology, 1st Chemistry, Elder Cup for Science, Telecom Central Science Award, NZFP Pulp & Paper Ltd Award, EW Evans Memorial Scholarship.
- Kevin Stewart : 1st Mathematics with Calculus, 1st Mathematics with Statistics, 1st Physics, Milne Cup for Mathematics, NZFP Pulp & Paper Ltd Award, E W Evans Memorial Scholarship.

FORM SEVEN ACADEMIC AND SPECIAL AWARDS

- Ruth Newfield : 1st Accounting, Student Council Cup for most dedicated Senior Councillor.
- Karen Krause : 1st History of Art
- Ella Hoefflich : 1st Practical Art
- Adam Ellis : 1st Computer Studies
- Patrick Stevenson : 1st Economics
- Karen Beets : 1st (Equal) English - Robyns Prize, Creative Arts Cup
- Lorna Wallace : 1st (Equal) English - Robyns Prize, 1st History
- Michaela Nill : 1st German
- Irene Yardley : 1st Geography, NZFP Pulp & Paper Ltd Award
- Larn Wilkinson : 1st Maori, NZFP Pulp & Paper Ltd Award, Nigel Stuart Memorial Trophy for contribution to Te Puna Wai Ora, Radio Forestland Prize for Effective Communication and Co-operation
- Gael Pryce : 1st Shorthand

FORM SIX SPECIAL AWARDS

- Jason Walters : Arohanui Trophy for the best student in Sixth Form Maori
- Markus Schonberger : Asmuss Valve & Precision Ltd Engineering Award for most improved student in Electronics
- Matthew Grant : Benchmark Building Supplies Award for Excellence in Craftmanship, Design and Technology
- Grant MacDonald : Morris, Black and Matheson Ltd Prize for diligence in Graphics & Design
- Joanna Hakaraia : Khoo Award for best performance in Sixth Form Mathematics, Bev & John Pudsey Award for the best Sixth Form Commerce Student
- Joseph Vavia : Jaycee Cup for Senior Oratory
- Wong Chun Wah : Schwed Award for achievement in Senior Art
- Andrea Baird & Simon Ormsby : Te Reo Rangatira Cup for Sixth Form Maori
- Adrian Le Gros : Holster Engineering Co Ltd Award for diligence in Engineering and Graphics & Design
- Tyson Wicks : Brass Band Prize for Musicianship, Co-operation and Assistance in running the band
- Mili Viita, Gunilla Eirnecke, Tracey Ryan, Gillian Carey, Oliver Ryan, Melanie Alderton : Whale Memorial Award for the Production Team of the best Video film
- Talimalama Taua : Samoan Award for the best student in Samoan Activities

FORM SIX SUBJECT AWARDS

- Chris McDonald : Accounting, Mathematics with Calculus, Mathematics with Statistics, Physics
- Lisa Mitchell : History of Art
- Ken Wibunsin : Practical Art
- Sharie Gray : Biology
- Rachael Parker : Chemistry
- Sherryl Reichenbach : Clothing
- Joanna Hakaraia : Commerce, English, Typing
- Philip Alloway : Computer Studies
- Megan Jones : Economics
- Dion Newth : Electronics
- Adrian Le Gros : Design & Technology - Metal
- Matthew Grant : Design & Technology - Wood
- Mili Viita : French
- Aaron Montgomery : Geography
- Daniel de Ruyter : History
- Tony Herlihy & Ngawini Poumako : Home Economics
- Jason Walters : Maori
- Joseph Vavia : Physical Education
- Keren Smith : Shorthand, Typing
- Matilda Ropiha : Science Grant MacDonald : Graphics & Design

FORM FIVE SPECIAL AWARDS

- Mariana Cripps : Maori Studies Parents Committee Cup
- Oliver Webb : Te Rahui Cup for best Pakeha student in maori
- Junior Tarai & Reelerman Monga : Cook Islands Award
- Sonny Tanuvasa : Samoan Award for best student in Samoan Cultural Studies
- Kelly Patridge : Tegel Creative Design and Cooking Competition - Commended, Ozahm Trophy for most improved Home Economics student

Kevin Pye	: Tokoroa Country Women's Institute Prize for best Practical work in Home Economics
Nicola Moore	: Mitchell Cup for best Practical work in Clothing
Rachel Newfield	: Tokoroa Chamber of Commerce Cup for best Form Five Commerce student, Tokoroa Business and Professional Women's Award for the Best English student in Form Five, Telecom Award for all round Excellence, Diligence and Achievement
Helen Mace	: Jan White Memorial Award for Diligence and Achievement in Art
Davina Edwards	: Tokoroa International Toastmistress Trophy for the Form Five Winner of the Speech Contest
Samantha Kay	: Tokoroa Business and Professional Women's Award for the Best English student in Form Five
Jason Lauder	: Asmuss Valve & Precision Ltd Award for Excellence in Engineering
Tony De Vorms	: Benchmark Building Supplies Award for most improved Woodwork student
Duane Cox	: Stanley Tools NZ Limited Award for Woodwork and Craftmanship

FORM FIVE SUBJECT AWARDS

Rachael Newfield	: Accounting, English (1st Equal), Mathematics
Katherine Sewell	: Art, Economics
Mingi Temarama	: Clothing
Samantha Kay	: English (1st Equal), Geography, German
Robert Winefield	: French, History
Brian Stewart	: Home Economics
Teokotal Taral	: Maori
Shane Dean	: New Zealand Mathematics
Duane Cox	: Technical Drawing

ADULT STUDENT AWARDS

Judy Singh	: Tokoroa Business & Professional Women's Club Trophy for Academic Excellence
Marie Swanson	: Taylor & Deweyer Trophy for Personal Achievement

SPORTS AWARDS

Bentley Cup, Canoeist of the Year	: Gard Grimsby & Tururangi Tarapu
L.H. Riley Cup, Senior Boys' Athletics Champion	: Crossley Ngapo
Wilson Cup, Senior girls' Athletics Champion	: Sarah Mace
McNeil Trophy, Winner of Senior Girls' Cross-country	: Sarah Mace
Ryan Trophy, Best Contribution to Sport in Attitude, and/or Participation	: Ngawini Poumako
Nibbs Trophy, Highest Points Scorer 1st XV Rugby	: Tommy Hayes
Grant Robinson Memorial Trophy, Most Outstanding Rugby Player	: Cailin Tonge
Grant Robinson Memorial Trophy, Most Outstanding Netball Player	: Kura Glassie
Gosnell Bat, Cricket's Best Performance on the Field	: Adrian Tocker
Morrissey & Cowley Trophy, All Round Sportsman of the Year	: Aaron Montgomery
McMillan Cup, Winner of Senior Boys' Cross-Country	: Tommy Hayes and Adrian Poi
Morrissey & Cowley Trophy, All Round Sportswoman of the Year	: Tanla Burke
Van Hasselt Cup, Contribution to Girls' Hockey	: Jocelyn Carey

CERTIFICATES

<u>Senior Boys</u>		<u>Senior Girls</u>	
Mid Island Championships	1st Long Jump	Mid Island Championships	2nd 800 m
	1st 100m		2nd 1500 m : Sarah Mace
	1st 200 m		
North Island Championships	2nd Long Jump	Mid Island Championships	2nd 800 m
Waikato Championships	2nd Long Jump		2nd 1500 m : Oliver Ryan
	2nd 100m		
	1st 200m : Crossley Ngapo		



Kevin Stewart



Sarah Mace

A FUNNY THING HAPPENED ON THE WAY TO THE FORUM



1915-ANZAC-1990

THE PAIN OF ...



Shrapnel,
flying bullets,
bayonets, no use,
killing,
orders given;
were they understood?



Fighting 'gainst the enemy
the Turks,
the flies,
themselves,
dysentery,
the heat
just too much to bear;
injured lying in pools of blood
no chances to survive.

Physical wounds,
numerous,
causing many to die
while being carried from the battleground
to a safer place
nearby.



The tales kept within
men whose memories
are painful all the time.
The truth left untouched,
still vivid in their minds.
Until one day stories were told,

little by little,
until we realise
what fools we are
thinking of war
as a game.



So taking a look at ourselves,
a nation
many years on,
with the story just been told,
we'd been drowning
in our own ignorance,
while our veterans
grew old.



Helen Mace



From The :- Outstanding squash player does it again

S.W.N

Naval cadet in top three

The Tokoroa Squash Club's outstanding junior player, Gerald Seymour has once again secured a place on the National Development Squad.

The squad which is for the top players in each age group, welcomed Gerald back for the third year running after his performance at the recent national junior team's events.

A Tokoroa youth topped his class recently and was third overall in the last basic Navy training exams at Auckland. Sean Allen, 16, enlisted as a medical cadet in April and began his basic training on June 1.

The intake of 90 trainees was broken up into classes of about 14 and successful trainees graduated last Friday.

Sean was born at Tokoroa and attended Tokoroa High School.

Fame calls out to Tok High school mime group

A mime created by a group of Tokoroa High School pupils will feature in an international literacy conference programme late next month.

On August 31 the group will present its mime of Kupe, Te Kaihi Whenua (Kupe, Fisher of Lands) at the conference in Auckland.

But the group will achieve wider recognition before then. Next week it will travel to Hamilton's College of Education to perform for secondary school pupils, and later to college of education students.

That visit will be followed by a second trip to Hamilton when the mime will again be performed and videotaped.

The video tapes will be sold to the general public and schools as a learning resource.

Kupe, Te Kaihi Whenua will be performed by a fourth form cultural studies group.

The group comprises Charles Langdon, Lotu Misa, Lawrence McCloskey, Jamie Storer, Natasha Healey, Glenda Bomford, Natarsha Mount, Glenn Rendall, Axel Janetske, Wendy Newth and Dee Anne Blanchard.

The mime of the legend of Kupe was born from an idea by three pupils in a fourth form cultural studies class last year.

The idea grew and more pupils were added to the presentation to form a cast composed of youngsters from NZ Maori, German and NZ European ethnic origins.



Career options offered

Those wanting to know more about career options and the necessary qualifications needed had the opportunity to learn more at the careers day held in July.

Fourth formers were informed about the subjects and skills needed for training courses and also information to help them decide what they want to do in the fifth form.

Seniors covered topics which included employers expectations, apprenticeships, the importance of maths and science and polytechnic courses and other avenues of training.

The open day was run with the help of the Tokoroa Kiwanis Club.

Speakers from NZFP Forests, Pinex and the Pulp and Paper division spoke to the senior group.

Transition to work teacher, Martha Lennon said the day was used to widen the expectations of students and to encourage them to stay at school and also to involve the community so they can see what is offered at schools now.

"It is no longer possible for youngsters to leave school and be trained on the job because everyone is looking for those who have had tertiary training," Mrs Lennon said.

"Although the students are becoming aware of it some parents do not realise the reality of today's workforce and increased education demands placed on us by employers."

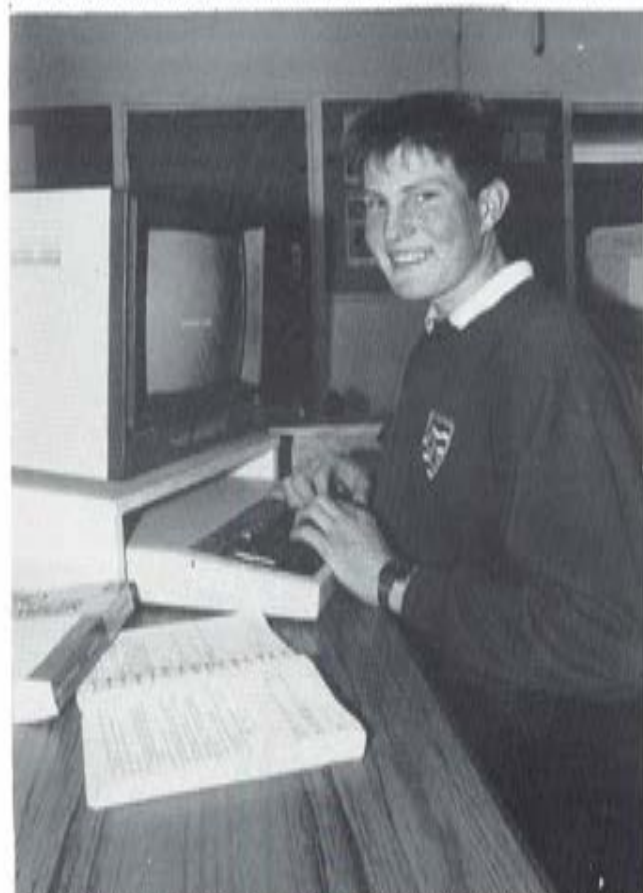

Tokoroa High School fourth form pupil Ross Gee working at a terminal during a Computer Awareness course on Careers' Day.

High School talent quest a crowd puller

There was standing room only in Tokoroa High School's hall last Wednesday night when the school stage its annual talent quest.

The capacity audience responded enthusiastically to the wide variety of entertainment provided by students and staff.

The winning item was "Soul Desire" - an all male group singing in three and four part harmony unaccompanied.

Members of the winning group, which judges described as outstanding and quite professional, were Ben Tologua, Mathew Maui, Sonny Tanuvasa, Sam Apulu, Mane Luatua, Harkness Letoa, Joseph Seau and William Stowers.

Second placegetter was a dance group performing under the name of "Swing Beat Crew". The group gave what was described as an exhilarating performance which called for slick co-ordination and boundless energy.

The dancers in "Swing Beat Crew" were Joseph Vavia, Tere Vavia, Ina Vavia, Teriki Simiona and Nerida Rawiri.

Two bands called "Chocolate Chippies" and "Soul Connection" shared third place.

"Chocolate Chippies" comprised Crossley Ngapo, Tyeson Wicks and Antony Pjacun while "Soul Connection" comprised Tunui Rau, Joey Ngati, Sonny Tanuvasa, Reelerman Monga, Echo Monga and Daniel Umax.

Leander Wawatai won best solo vocalist of the evening singing "Wind Beneath My Wings".

In addition to the talent quest entries items were given by the school instrumental group, school choir, Samoan and Cook Island groups and a comedy item by the staff singing "The Cut Lunch Blues" and "The Murder House Blues".

Organiser, Robyn Wolfe, said she was delighted with the success of the evening which raised \$1100 for the school's music department.



SW teacher sings her way to success

Kath Woodley - the Tokoroa High School teacher with many strings to her bow.

A late start to singing has not curbed Tokoroa High School teacher, Kath Woodley's chances of being one of New Zealand's top classical singers.

Ms Woodley only took up singing lessons three and a half years ago but proved her talent recently at the Cambridge Performing Arts competitions.

The competitions were for the top New Zealand singers and Ms Woodley secured the Lia Cup against 17 other singers and the Oratorio section against 15 competitors.

Ms Woodley said she was rapt with her winnings which also included a year's full time study leave which she will take at home and at Waikato University.

Ms Woodley also plays the piano and cello.

"I enjoy music and have always been interested in singing but I did not know how to," Ms Woodley said.

"I did not really want to get up on stage but once you get up there it is quite gripping."

Although Ms Woodley is a science and biology teacher now, she hopes to become a music teacher.

She is currently studying for the relevant exams to teach music.

"It is very exciting being on stage and it was very exciting to receive the awards."



1990 Waikato Science Fair

We were very proud of our entries into the Waikato Science Fair this year.

They were:

Sarah Mace - Fitness - 1st Senior Biological Display
- Plant & Animal Display

Irene Yardley - Behaviour, Plant & Animal Studies

Mary de Ruyfer - Magnetism

Sue Ellen Burgess & Jodi Carter - Horses

Nicola Blundell - Astronomy

Kaisalina Meliamu - E block plans - special prize conservation

Craig Treanor, Dion Richards, Richard Pook - Wind Generator 3rd prize, Senior Technology

Walter Williams - Beginnings of life

It takes a lot of commitment, time and effort for students to prepare their entries. We feel really pleased that once again our school was up there on the stage receiving prizes.



Squash champion Gerald Seymour has put Tokoroa in the history books after winning a National Age Group title for the second time.





A Forest View High School halfback tries to get away from Aaron Gray.



Tokoroa High School wing defence Marianna Cripps looks for a team-mate to pass to under pressure from Forest View High School's wing attack Leeanne Jolley during their netball game. THIS won 20-19.

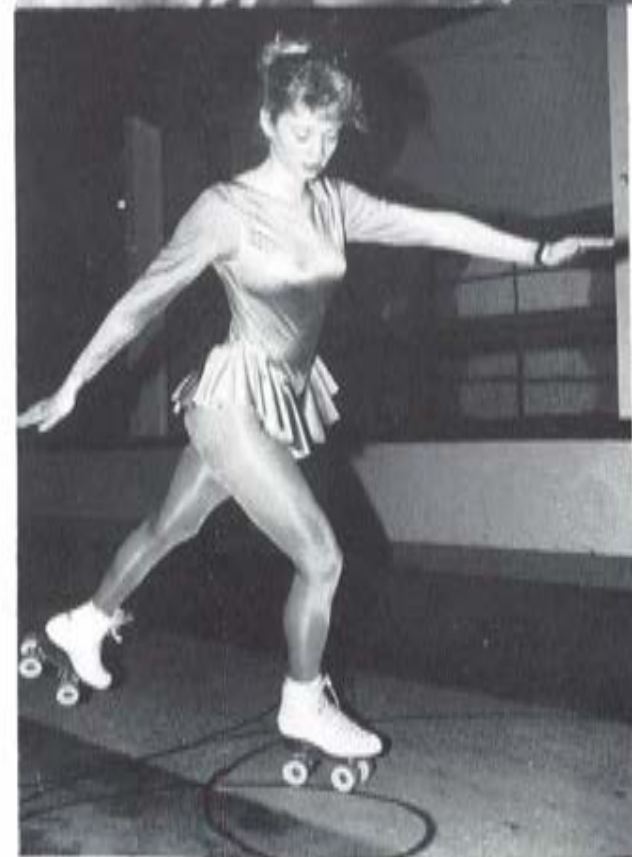

Natalie Keith (17) on her way to earning a gold medal during the medal tests at Tokoroa Skateworld.

F FORUM

E/MA

Back Row: Tasha Ngaira, Shane King, Ross Brydon, Robert Rogers, Darren Petry, Shane Harper, Rhonda Fargher.

Front Row: Rachael Newfield, Claire Scouse, Kirsten Mills, Joelene Orr, Andrea Baird, Tereapii Rota, Debra Beets and Shirall Bacon.

Absent: Jacob McLardy, Mane Luatua, Jason Penney, Carl Harris, Gillian Carey, Caroline Rota, M McKernan.



E/MM

Back Row: Patrick Stevenson, Malcolm Masters, Michael Lyttle, Nikolai Janetzke, Trevor Gates, Warren Wilson, Graham Mitchell.

Front Row: Kaisalina Mealamu, Robert Koloke, Ngawai Wilkinson, Mrs Maea, Lequisha Tangihaere, Emmett Fanning.



E/MU

Back Row: Mr Murray, Manu Ferguson, Marcus Schonberger, Gerald Seymour, Sonny Tanuvasa, Stephen Martin, Darren Hogan, Jason Hema, Adrian Poi, Laurie Wehipeihana.

Front Row: Julianne Davis, Janine Welch, Davina Edwards, Sharie Gray, Kura Glassie, Lorna Wallace, Michaela Nill, Dougal Devantier.

Absent: Hula Teaukura, Josephine Turia, Kerry Koloke, Fiona Collings.



E/NI

Back Row: Jan-Marie Whiripo, Lisa Paget, Sosefina Muelu, Dominic Lepu, Tai Pilato, James Edgar, Richard Pook, Dion Newth, Dorothy Momoemausu, Mareta Joe, Mr Nicol, Teoketai Daniel.

Front Row: June Mutlow, Kelly Paltridge, Leesa Pahewa, Gael Pryce, Sherryl Reichenbach, Christina Birch, Zarnia Easton, Victoria Oliver.

Absent: Tim Mangi, John Tuarae, Seia Togia.



F/PK

Back Row: Wilfred Cortesi, Andrew Siulepa, Ben Tolofua, Jamie Millward, James Mataiti, Richard Brown, Paul Erskine-Shaw.

Front Row: Mr Paki, Debbie Cameron, Rachel Erskine-Shaw, Devvie Campbell, Kendra Brinkley, Ray Ngaropo, Wayne Clatworthy, Walter Smith.



F/RW

Back Row: Maree Tangimataiti, Steven Ratai, Jeremy Sinclair, Brian Stewart, Mark Ahsin, Jason Joe, Ken Wibunsin.

Front Row: Sadie New, Nancy Wilks, Heather Alderton, Ruth Newfield, Treena Tetava, Maree Shaw, Eila Vartiainen, Grace Hewett.

Absent: Robert Hudson, Karen Nelmes.



E/WL

Back Row: Donna Lambert, Barry Edwards, Selwyn Richards, Michael Leger, Steven Ngatamariki, Matthew Mauai, Mr Woodley, Tururangi Tarapu, Timothy Banfield, David Cartan, Rebecca Lau.
 Front Row: Kirsty Watene, Nicole Debenham, Nicola Allan, Mellanie Phillips, Helen Mace, Angela McGowan, Genevieve Ihle, Tracy Allan.

Absent: Awhina Te Hiko, Ida Mahia, Selwyn Richards, Paul Millward, Lynette

**3A**

Back Row: Matthew Young, Adrian Cridge, Sam Pahewa, Calvern Reweti, Aaron Laird, Andrew Hakarala, Massey Tai, Tetera Eua.
 Middle Row: Frances Austin, Andrea Lockley, Mii Mamu, Julien Tihema, Robert Tewhia, Raymond Muir, Mihi Rata, Pam Rongo, Matthew Pocock.

Front Row: Mary de Ruyter, Nadine MacMillan, Paula Taniwha, Elaine Trickey, Rowina Montgomery, Bronwyn Pope, Jodine Capper, Pauline Tetevano, Kelly Loane.

Absent: Mala Stuart, Taumaa Taumaa, Kingi Tuapawa, Irene Hodge, Rosealie Stanley.

**3E**

Back Row: Conrad Taylor, Graeme Brear, Jeremy Butler, Lance Temarama, William Hirinuki, Mathew Paul, Fred Sellar, William Stowers.

Middle Row: Mr Ngarimu, (Tamati Ngarimu), Nicky Reid, Clinton Tudor, Rosina Davis, Nerida Rawiri, Kim Roberts, Sharlene Hunia, Angharad Kemp, Marita Marshall, Nicola Blundell.

Front Row: Denise Waddell, Arlina Tamati, Amanda Clapperton, Salote Cook, Adeline Southwick, Pauline Taiki, Dianne Tearoa, Rachel Althuisen.

Absent: Stephanie Skeilton, Natasha Wisniewski, Mathew Oliver.



R F O R U M

R/AN

Back Row: Mark Woodley, Robert Winefield, Adam Vonk, Alex Ryder, Chris McDonald, Avian Curtis, Oliver Webb, Dylan Percival, John Mapu, Jason Thompson.

Front Row: Mrs Atkins, Jocelyn Carey, Shona Hunt, Shelley Walton, Amanda Vautier, Bronwyn Baldick, Leeanne Waddell.

Absent: Maria Daniels, Aaron Montgomery, Larn Wilkinson.



R/GE

Back Row: Mrs Gee, Megan Fitzgerald, Sarah Mace, Jason Walters, Kevin Stewart, Tommy Hayes, Michael Greenough, Kylie Edwards.

Front Row: DeeAnne Blanchard, Karen Beets, Jodine Mear, Rachael Verhaegh, Gunilla Einecke, Emma Hill, Rawinia Ward, Moira Anderson.

Absent: Gard Grimsby, Tara Lockington, Andrew Lachmaiya, William Mariu, Matthew Grant, Teremoana Anthony.



R/KB

Back Row: Simon Ames, Brian Tereu, Ben Glassie, Glen Meads, Jade Richards, Deon Tereu, Russell Daken, John Natua, Mark Ward, Jason Pussell.

Front Row: Mrs Kerbers, Deanne Genhoefer, Sandra Wilson, Miranda Tock, Melanie Alderton, Jacqueline O'Brien, Tracy Tangimataiti, Silomiga Weiss.



R/ME

Back Row: Kelly Montford, James Swanson, Brian Reid, Phillip Alloway, Matthew Whinney, Mark Draper, Jason King.
 Front Row: Jay Critchley, Rachel Greenough, Melanie Sutton, Karen Krause, Natalie McKinlay, Jason Lauder, Miss Mische.



R/MH

Back Row: Emile Burch, Taratua Taratua, Devon Gabriel, Paul Montford, Phillip Reid, Craig Scott, Paul McCann, Mr Mutch.
 Front Row: Marie Martin, Nicola Mackey, Lisa Paraku, Kimberley Rothwell, Lania Takiri, Roslyn Dehar, Sam Kaye, Jodi Gilbert.



R/PD

Back Row: Mrs Pudsey, Lorraine Uerata, Juanita Allen, Walter Williams, Mark Glassie, Colin Glass, Joey Ngati, Mavis Poumako.
 Front Row: Kylee Treadaway, Arama Ngapo, Katherine Sewell, Alex Batty, Anita Gibb, Debbie Crockett, Chun Wah Wong, Natasha Parker.
 Absent: Aroha Tamati, Hesper Tahau, Lindsay Moore.



R/RI

Back Row: Michael Butler, Junior Tearoa, Jason Tuinier, Nicki Butterworth, Dion Richards, Tumui Tausi, Steven Sattler.

Front Row: Jane Kaye, Keren Smith, Tracey Ryan, Nicola Tatham, Natalie Kaio, Mr Beban.

Absent: Jayd Hickey, Betty Placid, Stacy Tai, Lorraine Drollett, Akeina George, Rosaleen O'Connor.



3S

Back Row: Murray Ginns, Clifton Butler, Nga Lawrence, Justin Reti, Delaney Thompson, Echo Monga, Ben Altman, Greg Sewell.

Middle Row: Mr Bentley, Phyllis Marsh, Katrina McQuade, Clinton Tangahau, Elijah Phillips, Toru Natua, Alan Togia, George Nathan, Chris Southwick, Brad Flavell.

Front Row: Katherine Dennis, Lea Satchell, Mary Neil, Louise Hewett, Wendy Machen, Tungane Makiakama, Janice Bell, Julie Paul.



3T

Back Row: Andrew Atkinson, Louis Armstrong, Aukuso Aukuso, Arryn Dawson, Paniora Daniels, Richard Hikairo.

Middle Row: Damon Iversen, Robert Thompson, Ross Kilgour, Teresa Aitupuna, Maria Gernbofer, Amanda Gordon, Leona Tate, Paul Lovett, Jonathan Bishop, Deane Judson, Mrs Mitchell.

Front Row: Adra Dehar, Rachel Baker, Retiana Mahanga, Hayley Royal, Margaret Vaikai, Lauren Hawera, Joanne Birch, Melissa Stevenson.

Absent: Papatoa Ramea, Pare Maui.



U F O R U M

U/CH

Back Row: Axel Janetzki, Neil Joyce, Stewart Reuben, Morning Ngam-etua, AuMareva Shepherd, Aoterangi Moetu, Terry Carter, Timothy Brinkley.

Middle Row: Carroll Fargher, Jay Cowley, Paul Lachman, matthew Verhaegh, Jun Ogino, Lawrence McCloskey, Mr Christophersen.

Front Row: Rachel Parker, Judith Stevens, Debbie Tanoa, Glenda Bomford, Raewyn Bates, Lisa Mitchell, Carlie Leslie, Lisa Morris.



U/CT

Back Row: Henry Hale, John Waring, Jayson Tangimataiti, Arron Gray, Richard Homan, Adrian Tocker, Mr Coulter.

Front Row: Kylie Anderson, Sandra Paget, Tracey Simmonds, Therese Ford, Nicola Moore, Jenny Shailer, Natasha Paul, Naomi Batley.



U/DP

Back Row: Aorangi Puata, Bridget O'Brien, Lotu Misa, Brendan Fitzpatrick, John Ponga, Sam Apulu, Glen Shepherd, Solomon Rai, Mr Depree.

Front Row: Tanya Tetava, Renn Erceg, Laura King, Angelina Janssen, Danette Jonson, Irene Yardley, Arianna McRoberts, Jenny Masters.

Absent: Grant McDonald, Eileen Farrar.



U/MC

Back Row: Jacob Tekurapa, Paul Nairn, Paul Martin, Tino Tuau, Jarred Morgan, Timothy Vonk, Stacey Thompson, Stuart MacTier.
Front Row: Lysandra Stuart, Martha Riklau, Kylie Rowe, Debbie Keyte, Heather Smith, Aroha Riki, Mr McHugh.
Absent: Tai Hodge, Anthony Bone, Ma Petero, Philip Townsend.



U/RO

Back Row: Mr Robyns, Mill Viita, Michael Tock, Nathan Iversen, Nga Hirinuki, Reynold Ropiha, Damian Phipps, Edwin Tuarae, Megan Jones, Tomi O'Brien, Judi Singh.
Front Row: Tania Burke, Miranda Snell, Carol Kemp, Monique Portegys, Mingi Temrama, Kylie Bryers, Natarsha Mount, Wendy Newth.
Absent: Teokotai Tarai, Angelene Tatham, David Watene, Abbey McLardy, Joshua Teinakore, Jamie Storer, Chance Redden.



U/TE

Back Row: Charles Langdon, Glenn Rendall, John Christie, Ian Grant, Ryan Stobie, Brendon Cridge, Ben Mahanga.
Front Row: Murray Maklakama, Vanessa Nelson, Lucilla Reinsfield, Kiri-Ann Innes, Kylie Tatham, Tashlin Jones, Tina Singh, Mr Taufalele



U/YD

Back Row: Ronald Filer, Brendon Brown, Tony Herlihy, Denny Govender, Kevin Pye.

Front Row: Bernadette McGregor, Matakapua Glassie, Pati Enua, Michelle Farrell, Antonina Horn, Anna Vano, Mrs Yardley.

Absent: Natasha Healey, Katrina Ifa, Tereapii Ivitu, Mark Brown, Anna Glassie, Jo-Anne Kara.

3R

Back Row: Stephen Iorangi, Victor Kihirini, David Hakaraia, Brent McClure, Iarere Gabriel, Junlor Ngatamariki, Gregory Pearce, Edge Standen.

Middle Row: Kathleen Erskine-Shaw, Leeanne Milne, Janeya Singh, Leonard Hansen, Mark Steadman, Hayley Rodwell, Paula Ryan, Leanne Scott, Joseph Tapsell, Paul Miteff, Brendon Welch, Mr Johns.

Front Row: Bonnie Sadaraka, Taria Paul, Lisa Thompson, Kathryn Petero, Chantel Tai, Kelly Maney, Valerie Horn, Anthony Vargas.
Absent: Simon Mace, Lionel Kemp, Kathleen Samuels.

30

Back Row: Mrs Flavall, Desmond Hoeflich, Nicholas Cameron, Hayden MacMillan, Karl Taniwha, Mark Phillips.

Middle Row: Ernest Fraser, Donella Aorangi, Kapree Kiripa, Chervon Pia, Alison France, Donella McOnie, Latisha Hoera, Mr Johns.

Front Row: Carla Le Gros, Katishe Grant, Manea Drollett, Heather Barr, Natasha Maker, Katherine Ford, Margaret Matthews, Andrea Cox.



M

F O R U M

M/BR

Back Row: Trevor Deam, Mark Service, Jason Togia, Daryl Claperton, Duane Cox, Clayton Blundell, Shane Dean.
Front Row: Mrs Brunton, Lisa Watene, Shelley Brown, Hayden Ngata, Katrina Middlemiss, Andrew Pook, Jason Bluett, Yana White.



M/CN

Back Row: Heath Young, Walter Tuakana, Noel Westlake, Adam Ellis, Nicholas Wiki, Gary Seerden, Corey Thompson, William Ransfield.
Front Row: Ben Morunga, Mrs Christophersen, Tere Vavia, Bonnie Kea, Felicity Misiluti, Tenaka Ngaira, Karina Wiley, Emily Trebilcock.
Absent: Lecia Yeeles, Simon Ormsby, Juanita Te Marama, Craig Treanor.



M/GR

Back Row: Douglas Johnson, Nathan Whale, Adrian Baxter, Ross Gee, Wayne Winter, Dean Taylor, Shane McDonald.
Front Row: Mr Griffiths, Jas Tereu, Melanie Tatham, Natalie Allan, Wiki Papa, Melanie Gleason, Debbie Taylor, Tracy Gilmour.



M/TI

Back Row: Mr Wilson, Paul Douglas, William Spargo, Tony Devorms, Maka Hiva, Maurice Davis, James Hovind.
 Front Row: Moe Putal, Kiri McLean, Natasha Taylor, Kerrie Cochrane, Kim Blomfield, Joanna Hakarala, Grace Scott, Lisa Pitman.

M/OL

Back Row: Mr Olding, Catherine Lepa, Carson Arrol, Allies Edge, Tukatara David, Daniel Fitzpatrick, Renee Ames.
 Front Row: Irene Chong-nee, Kylie Dewar, Ruth Tuakana, Raewyn McRoberts, Chelsea Tahau, Wendy Maaka, Angela Bond.
 Absent: Silga Roberts, Naumai Warren, Nicholas Machen, Andreas Weiss, Brent Edwards.

M/OS

Back Row: Angela Johnson, Campbell Gordon, Adrian Le Gros, Stephen Livingstone, Nigel Hammersley, Rewiti Brown, Greg Draper, Reelerman Monga, Brendon Phillips, Ina Vavia, Mr Olsen.
 Front Row: Lorraine Laird, Kristy Anderson, Tanya Poi, Melony Spargo, Ngawini Poumako, Sheree Reidinger, Stacey Pollard, Kerry Shailer.



3E

Back Row: Mr Drake, Wayne Ryder, Frederick Kawhena, Henry Hale, Scott Guyton, Ronald Westlake, Jeremiah Mason, John Young, James Thompson.

Middle Row: Donna Sargeant, Elizabeth Gascoyne, Shane Carruthers, Jackson Te Nahu, Rangī Davis, Brent Tangaroa, Malcolm Clair, Lyndon Cox, Junior Tuakana, Metua Rauli, Lee William.

Front Row: Julieanne Bruce, Fiona Andersson, Sarah Taylor, Lorena Budden, Alice Vaikal, Stephanie Poko, Tami Wilson, Patricia McGregor, Bernadette Hastie.



M/RS

Back Row: Alan Tetevano, Francis Mikara, Mania Paiti, Jeremy Vickers, Richard Glass, Terikivaine Simiona, Rhys Crawford, James Pocock.

Front Row: Marina Stowers, Natasha O'Brien, Vanessa Trotman, Anzia Taumata, Stephanie Steel, Rochelle Annas, Mrs Robyns.

Absent: Jeremy Clark, Enos van der Putten, Junior Tarai, Michele Clinch.



$$E = MC^2$$

Autographs

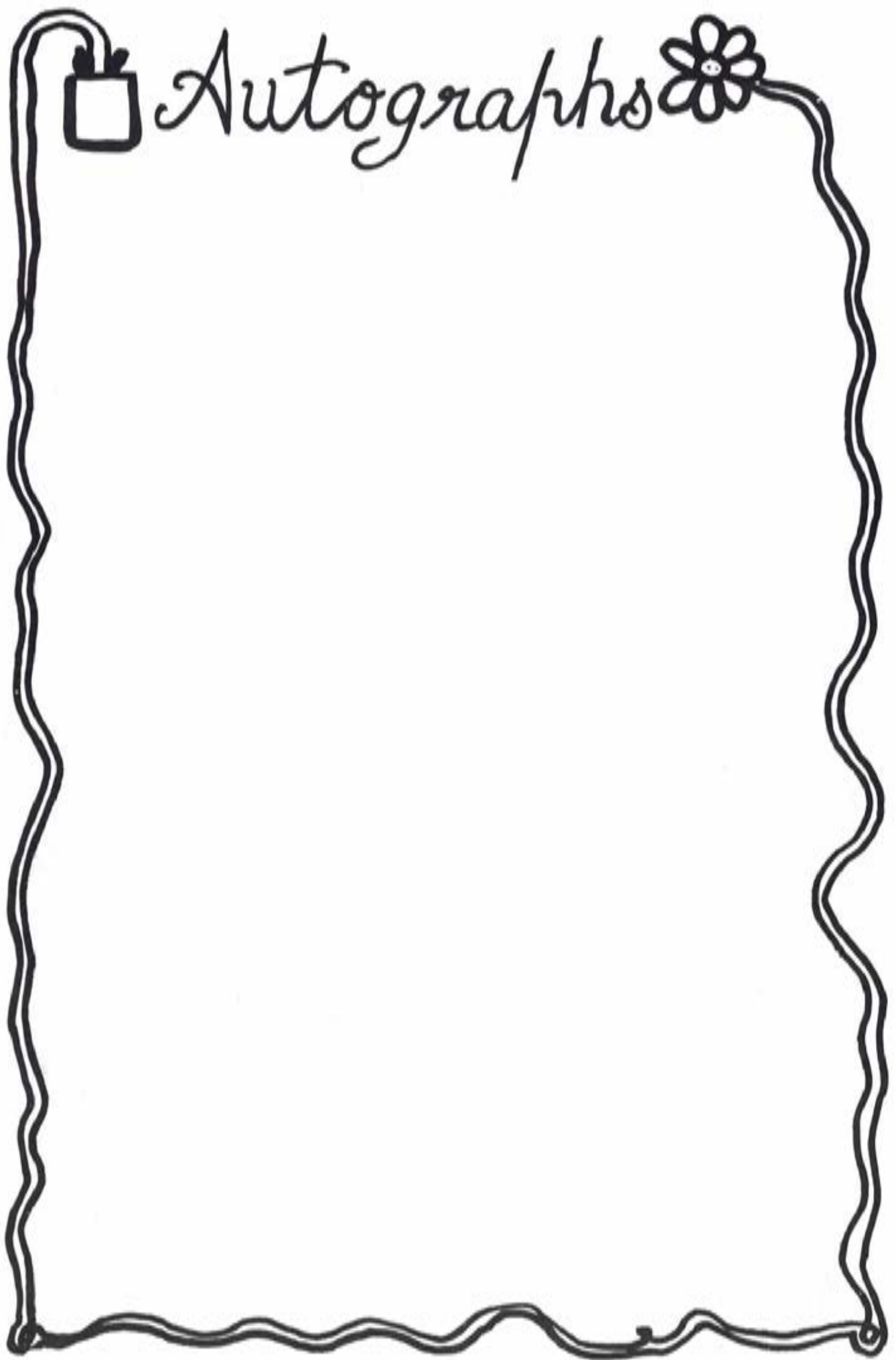

SENIOR PRIZEGIVING & LEAVERS' DINNER

"An outstanding success"

"A wonderful night"

"The best prizegiving ever"

These were some of the superlatives which flowed from the new format Senior Prizegiving held last Thursday evening. This year's prizewinners received their prizes at a Special Formal Dinner held in the school hall and attended by over 240 Senior students, parents, staff and Board of Trustees members.

Professional caterers served an excellent three-course dinner in the hall which had been transformed for the occasion by beautiful and elaborate decorations on a green, white and silver theme. The quadrangle, which was under canvas and decorated by ponga trees, coloured lights and balloons, provided an excellent buffet area. Even the weather was perfect.

The guest speaker, Temuera Morrison, from TVNZ who

has enjoyed success in such programmes as "Gloss" and "Never Say Die", commented to the audience that in the seventeen prizegivings he had spoken at, this one was by far the best - We'd have to agree!

A number of very polished items including a piano and flute duet, a modern dance troupe (Swing Beat Crewe), and Brass Band and an unaccompanied male octet (Soul Desire) swinging four and five part harmony gospel songs, were warmly received by the large audience, and provided excellent contrast to the formal speeches and presentations.

Congratulations to staff, students and parents who were directly involved in the planning of this memorable evening.



MEDIA COMPETITION

Last year our sixth form students won all three categories of a locally sponsored competition - a hollow victory as the other four South Waikato Secondary Schools failed to take up the challenge of that competition.

Once again we were fortunate enough to have "Descon Video Services" offer this media competition to Secondary Schools - this time the circle of schools was widened beyond the South Waikato to include Tauranga, Cambridge, Te Awamutu and Taupo. Hanimex NZ Ltd, replaced the Tokoroa Expansion Trust as the second sponsor with an offer of the new high quality (double magnetic coated) Pro Video Tape as a prize for each member of the winning production teams.

Excitement ran high when the videos were judged with our school once again winning all three categories - Grant MacDonald designed a quite outstanding newspaper ad promoting Tokoroa - to win \$150.00. The 5 minute video promoting "our town" was won by members of Mrs Law's English class - Abbey McLardy, Jocelyn Carey, Kerrie Cochrane, Tony Herlihy, Damian Phipps and Cynthis Dean. The 60 second Advertisement video on "our town" was won by Mr Robyns' English class - Joanne Kara, Tanya Tetava, Mavid Poumako, Eileen Farrar and Sam Livingstone. The 5 minute video won \$300.00 and the 60 second video won \$200.00 - donated by Descon Video Services.

We really appreciated having Mr and Mrs Zein of "Descon Video Services" and Mr Phil Curtis (Manager, Magnetic Products Division) of Hanimex NZ Ltd attend a special Senior Assembly to present the prizes to the students. The presentation was followed by a screening of the winning video on the large screen and a press photography session.

OUR SINCERE CONGRATULATIONS TO THE STUDENTS for their dedication and enthusiasm in this project.

Funky Tokoroa

Ha Ha-Ha Ha-Ha Ha
Ha Ha-Ha Ha-Ha Ha
Stepping out today
Just looking for some action
I know a town called Tokoroa
A place for satisfaction
We hang out at the mall
A place of fun for all
So come to Tok and do some shopping
And you will have a ball
The people there are friendly
The fashion there is trendy
We have a mill that's really cool
and lots of people work there
So I've gotta be going over
To this town called Tokoroa
And when I asked this guy what
was on his mind
He said "FUNKY TOKOROA"
Ha Ha-Ha Ha-Ha Ha
DISCOVER TOKOROA



Dog's view a real winner

Grant MacDonald and Sam Livingstone, with other team members behind, after their success in school video and newspaper competitions. Back row, from left are Damian Phipps, Kerrie Cochrane, Joanne Kara, Abbey McLardy and Tony Herlihy. Front row, from left are Mavis Poumako, Eileen Farrar, Tanya Tetava, and Jocelyn Carey.

Presenting Tokoroa from a dog's point of view helped a group of Tokoroa High School students win the recent secondary schools' video competition.

The competition run by Descon Video Services and Hanimex NZ invited secondary schools from Taupo, Cambridge, Te Awamutu, Tauranga and the South Waikato to promote their own town either in a five minute video, one minute advertisement or a newspaper advertisement.

Students from Tokoroa High School won all three categories.

THE PIC OF THEM ALL

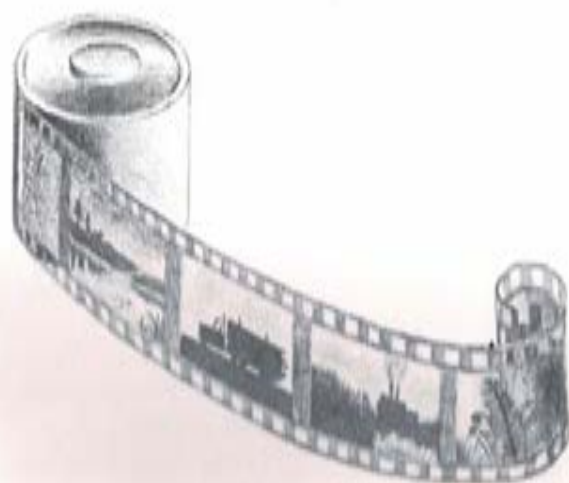
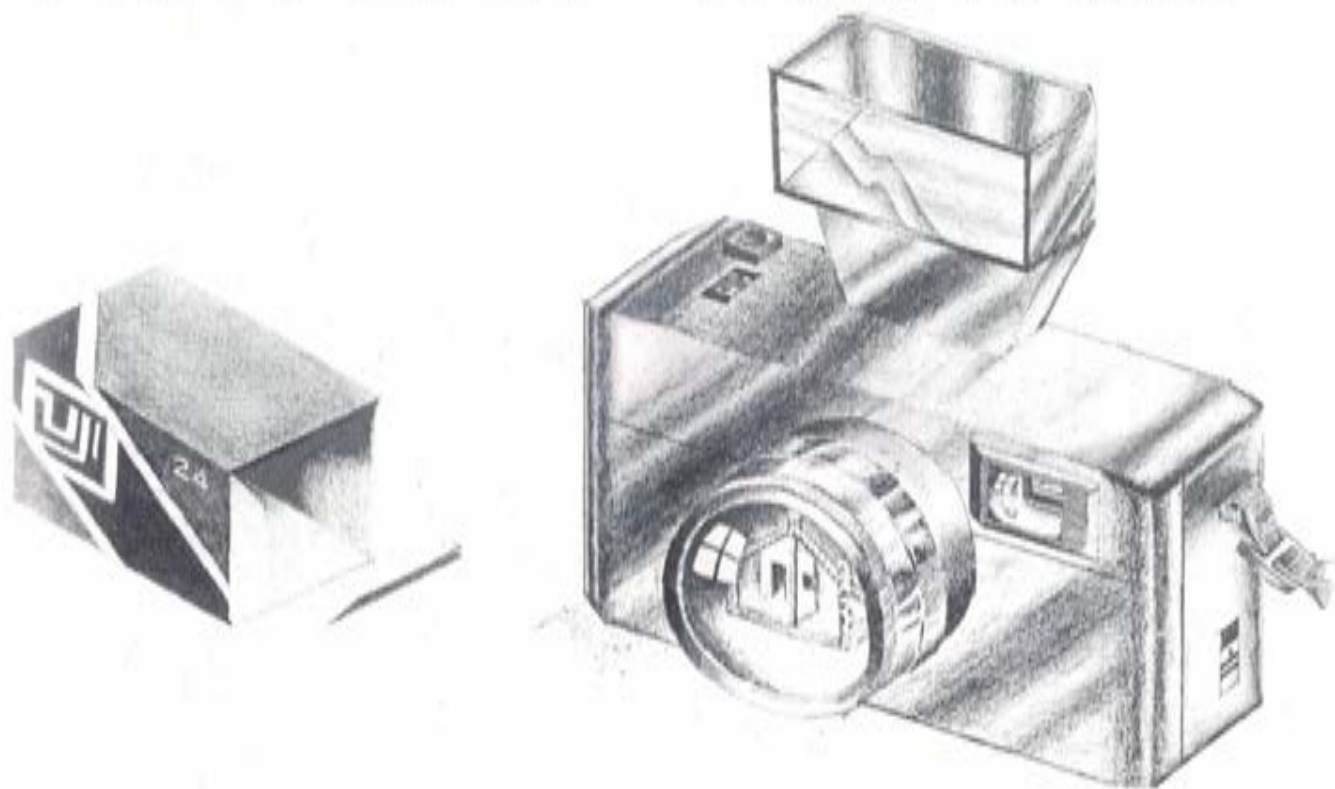

Tokoroa - the centre of the North Island. Within an hour's drive are Rotorua, Taupo, TeAwanutu, Tauranga.

What other town is so close to so many?

Anyone interested in hunting, fishing, tramping, forestry, moto-cross, farming or water-sport, Tokoroa is the place to be. Tokoroa, the thriving heart of the North Island.

TOKOROA



Magazine Committee

*Michael Robyns
Shellee Mischewski
Lisa Watene
Natalie Keith
Megan Jones
Helen Mace
Arama Ngapo*

Acknowledgements to:

*South Waikato News
Mr M. Fenton (photography)
Mrs Pudsey
Commercial Department
Mrs M. Trebilcock
Grant MacDonald*